Contents

Introduction	2
In brief	8
Keys, Doors, and Windows	18
Seats and Restraints	33
Storage	79
Instruments and Controls	88
Lighting	124
Climate Control	133
Driving and Operating	143
Vehicle Care	166
Service and Maintenance	223
Technical Data	226
Customer Information	233
Index	238

Introduction

Introduction

This manual provides practical guidelines on driving and caring for your Saab.

Although this manual describes the most important differences between model variants, it does not specify the equipment or features included on individual models.

Import and distribution of Saab automobiles, spare parts, and accessories are handled exclusively by Saab Cars North America.

We recommend that you read through the manual before taking the car out for the first time and keep it in the car for future reference.

To find a specific item, use the overviews given at the start of the manual. A table of content is included at the beginning of each section of the manual, and there is also a comprehensive index at the back of the manual.

The car is supplied with a Warranty and Service Record book which contains important warranty information and specifies regular maintenance

that is to be carried out. Also included is an Infotainment System manual and tire warranties.

Since the policy at Saab is one of continual improvement, we retain the right to incorporate modifications and to alter specifications during production without prior notice.

If you have any questions concerning your car, its equipment, the warranty conditions, etc., your Saab dealer will be pleased to help, or you may call the Saab Customer Assistance Center at 1-800-955-9007 or e-mail them at saab-crm@saabusa.com.

Enjoy the road ahead!

Saab Automobile AB

Saab Automobile AB does not accept liability for any damage caused by the fitting of spare parts, exchange parts, or accessories not approved by Saab Automobile AB.

Using this Manual

- This manual describes all options and features available for this model. **Certain descriptions,**

including those for display and menu functions, may not apply to your vehicle due to model variant, country specifications, special equipment, or accessories.

- The "In brief" section will give you an initial overview.
- The table of contents at the beginning of this manual and in each chapter shows where the information is located.
- The index will enable you to search for specific information.
- The Owner's Manual uses the factory engine designations. The corresponding sales designations can be found in the chapter "Technical data".
- Directional data, e.g., left or right, or front or back, always relates to the travel direction.
- Display messages and interior labeling are written in **bold** letters.

Danger, Warnings, and Cautions

⚠ Danger

Text marked **⚠ Danger** provides information on risk of fatal injury. Disregarding this information may endanger life.

⚠ Warning

Text marked **⚠ Warning** provides information on risk of accident or injury. Disregarding this information may lead to injury.

Caution

Text marked **Caution** provides information on possible damage to the vehicle. Disregarding this information may lead to vehicle damage.

Symbols

Warning labels

Radiator fan, A/C system



The warning label is located in the engine compartment.

Radiator fan may start at any time.

Refrigerant at high pressure.

Do not loosen or remove the A/C system fittings before discharging the A/C system. Improper service methods may cause personal injury. System to be serviced by qualified personnel only. For instructions, consult dealer manual.

The A/C system complies with SAE J639.

Battery



The warning label is located in the engine compartment.

- No sparks, open flames, or smoking.
- Always shield eyes. Explosive gases can cause blindness or injury.
- Keep the battery out of reach of children.
- The battery contains sulfuric acid which could cause blindness or serious burn injuries.

- See the Owner's Manual for further information.
- Explosive gas may be present near the battery.

Coolant



The warning label is located in the engine compartment.

Never open when engine is hot!

AIR BAGS

WARNING

EVEN WITH ADVANCED AIR BAGS

- Children can be killed or seriously injured by the air bag.
- The back seat is the safest place for children.
- Never put a rear-facing child seat in the front.
- Always use seat belts and child restraints.
- See owner's manual for more information about air bags.

MÊME AVEC DES SACS GONFLABLES INTELLIGENTS

- Les enfants peuvent être tués ou gravement blessés par le sac gonflable.
- Le siège arrière est l'endroit le plus sûr pour les enfants.
- Ne jamais placer à l'avant un dispositif de protection pour enfant faisant face à l'avant.
- Toujours utiliser les ceintures de sécurité et les ensembles de retenue pour enfant.
- Voir le Guide du propriétaire pour plus d'information à propos des sacs gonflables.

© 2013

This warning label is located on the front side of both sun visors.

- Children can be killed or seriously injured by the air bag.
- The back seat is the safest place for children.
- Never put a rear-facing child seat in the front.
- Always use safety belts and child restraints.

Xenon headlight



The warning label is located in the engine compartment.

Contact a Saab dealer if a Xenon headlight needs to be replaced.

This label is only found on cars with Xenon headlights.

Cross-Wheel Drive Cars

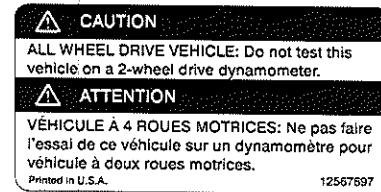

The warning label is located in the engine compartment.

Do not test this vehicle on a 2-wheel dynamometer.

6 Introduction

Changing wheels

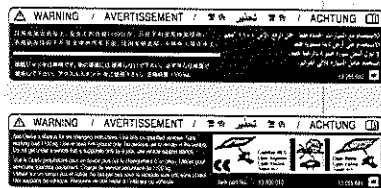

The warning label is located under the trunk lid.

- Use jack only on specified vehicle.
- Safe working load 2,425 lbs.
- Use jack on level firm ground only.
- Do not get under a vehicle that is supported only by a jack, use vehicle support stands.

Page references

Page references are indicated with

◊. ◊ means "see page".

In brief

Initial Drive Information

Unlocking the Vehicle

Remote Control System

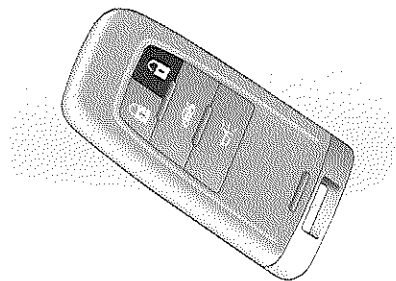

Press button  to unlock the doors and trunk. Open the doors by pulling the handles. To open the trunk lid, press the button under the trunk lid molding.

Press button ; only the trunk is unlocked and opens.

Remote Control ⇨ 18, Central Locking System ⇨ 20, Trunk ⇨ 24.

Passive Entry System

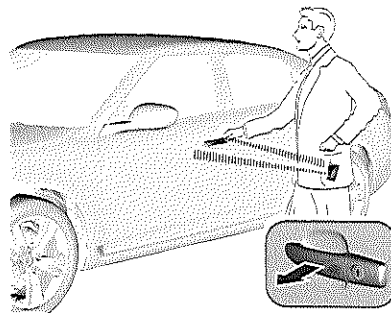

Pull the door handle to unlock the vehicle and to open the door. To open the trunk lid, press the button under the molding. The remote control needs to be on the driver's person.

Passive entry system ⇨ 20.

Seat Adjustment

Power seat adjustment

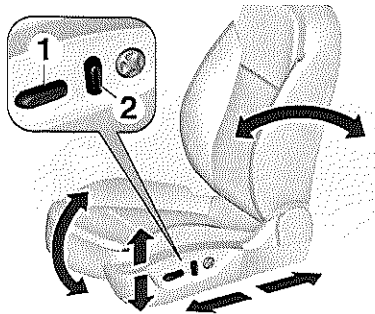

Operate switches.

Legroom positioning	= move switch (1) forwards/backwards
Height adjustment	= move switch (1) upwards/downwards
Inclination adjustment	= move switch (1) upwards/downwards at front
Backrest adjustment	= turn switch (2) forwards/backwards

Head Restraint Adjustment

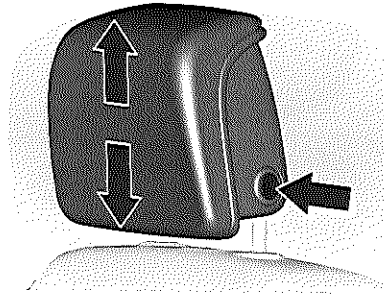

Press release button, adjust height, engage.

The headrest must not be in highest position, when seat is in highest position.

Head restraints, rear head restraints ⇨ 33.

Safety Belt

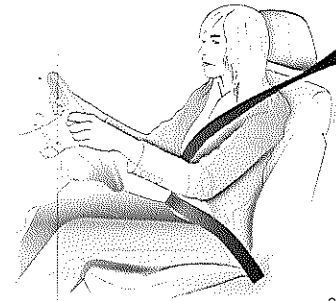

30049

Pull out the safety belt and engage in belt buckle. The safety belt must not be twisted and must fit close against the body. The backrest should be adjusted to allow an upright driving position.

To release belt, press red button on belt buckle.

Seat Position ⇨ 34, Safety belts ⇨ 40, Airbag System ⇨ 46.

Mirror Adjustment

Interior mirror

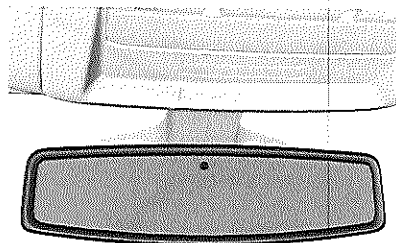

Swivel mirror housing into right position.

Mirror can also be adjusted in height.
Automatic Anti-Glare Interior Mirror
↔ 30.

Exterior Mirrors

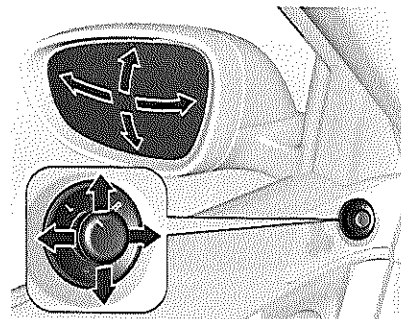

Select the relevant exterior mirror and adjust.

Exterior Mirrors ↔ 28, Power Mirrors
↔ 28, Automatic Dimming Mirrors
↔ 29, Folding Mirrors ↔ 28,
Heated Mirrors ↔ 29.

Steering Wheel Adjustment

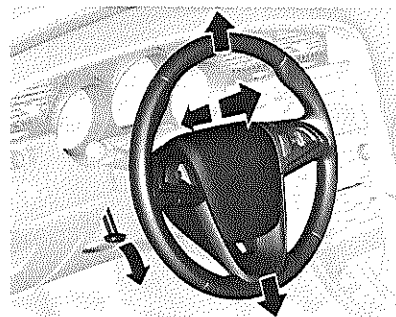

Unlock lever, adjust steering wheel, then engage lever and ensure it is fully locked. Do not adjust steering wheel unless vehicle is stationary.
Airbag System ↔ 46.

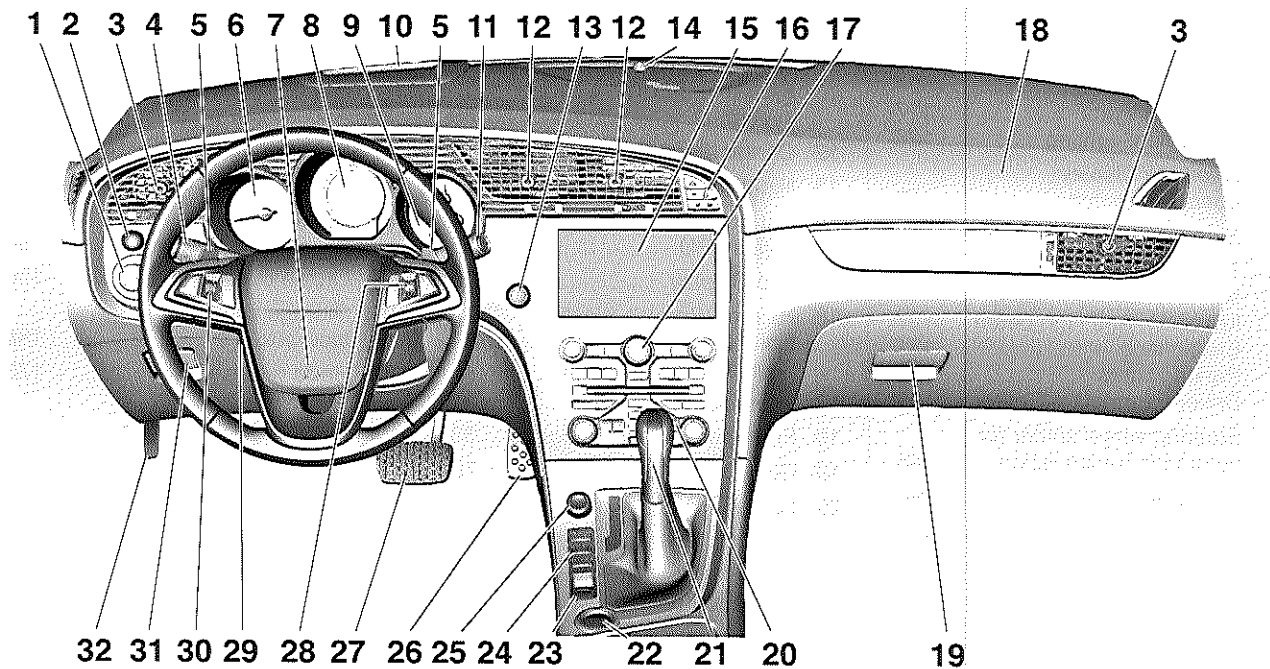

Instrument Panel Overview

1	Light switch	124	10	Head-Up Display	107	25	Traction Control system	153
	Front fog lights	127	11	Windshield wiper, windshield washer system, headlight washer system	89		Electronic stability program	148
	Instrument lighting	128	12	Center air vents	140		Drive sense	154
2	Head-Up Display operation switch	107	13	Night panel	128	26	Accelerator pedal	143
3	Side air vents	140	14	Anti-theft alarm system status LED	26	27	Brake pedal	150
4	Turn and lane-change signals, headlight flash, low beam and high beam ...	127	15	Info-Display	105	28	Audio/Phone controls	88
	Exit lighting	131	16	Hazard Warning Flashers ..	126	29	Steering wheel adjustment	88
	Parking lights	128		Child locks	24	30	Cruise control	156
	Driver Information Center ...	103		Central locking system	20	31	Storage compartment, fuse box	186
5	Steering wheel shifter for automatic transmission	148	17	Infotainment system	11	32	Hood release lever	170
6	Tachometer	94	18	Front passenger airbag	53			
7	Horn	89	19	Glovebox	79			
	Driver airbag	53	20	Climate control system	133			
8	Speedometer	93	21	Selector lever, automatic transmission	146			
	Odometer	93	22	Start/Stop button	144			
	Driver Information Center ...	103	23	Parking brake	151			
9	Fuel gauge	94	24	Parking assist system	157			
	Boost gauge	94		Lane departure warning	159			
	Engine coolant temperature gauge	95						

Exterior Lighting

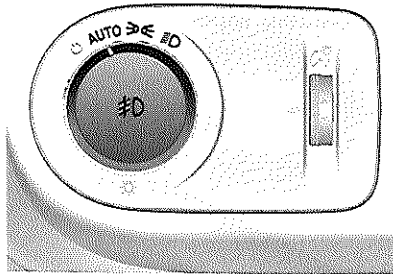

Turn light switch

- ⊕ = Activation or deactivation of the Automatic Light Control
- Auto** = Automatic Light Control: Headlights are turned on and off automatically.
- ↔ = Parking lights
- ↔ = Headlights

Press

⊕ = Front fog lights

Lighting ⇨ 124.

Headlight Flash, High Beam and Low Beam

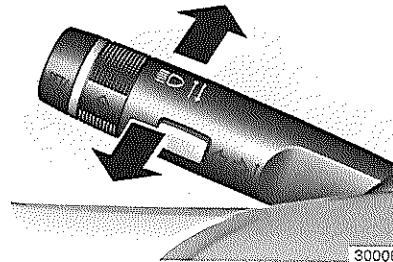

- Headlight flash = pull lever
- High beam = push lever
- Low beam = push or pull lever

Automatic Light Control ⇨ 125, High Beam ⇨ 125, Headlight Flash ⇨ 125.

Turn and Lane-Change Signals

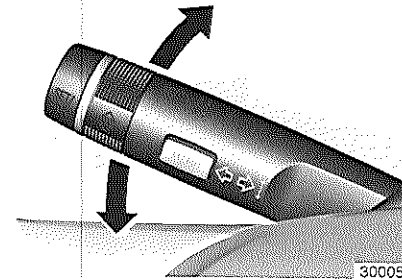

- Right = lever up
- Left = lever down

Turn and Lane-Change Signals ⇨ 127, Parking lights ⇨ 128.

Hazard Warning Flashers

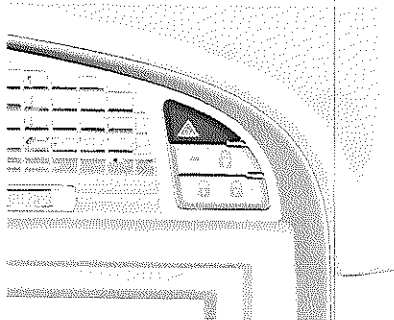

Operated with the  button.
Hazard warning flashers \diamond 126.

Horn

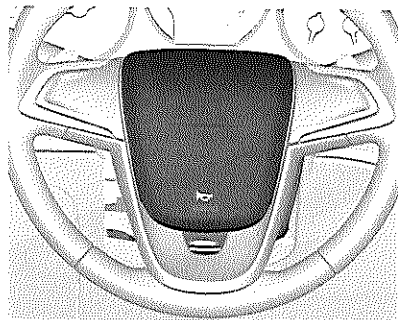

Press .

Washer and Wiper Systems

Windshield wiper

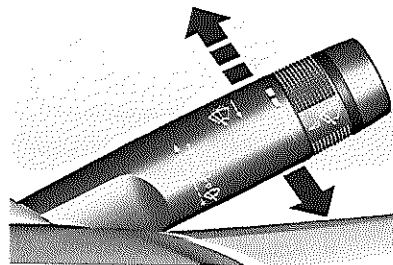

- 2** = fast continuous
- 1** = slow continuous
-  = automatic wiping with rain sensor
- O** = off

For a single sweep when the windshield wiper is off, press down the lever.

Windshield wiper \diamond 89, Wiper blade replacement \diamond 175.

Windshield and headlight washer systems

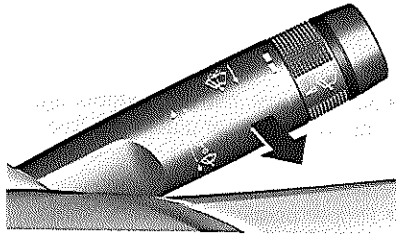



Pull lever.

Windshield and headlight washer system ↻ 89, Washer fluid ↻ 174.

Climate Control

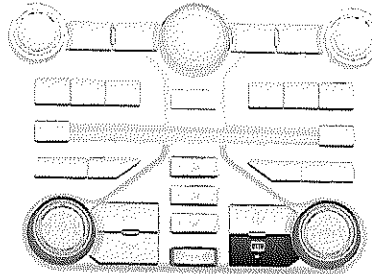
Heated Rear Window, Heated Mirrors



Heating is operated by pressing the  button.

Heated Rear Window ↻ 32.

Demisting and Defrosting Windows

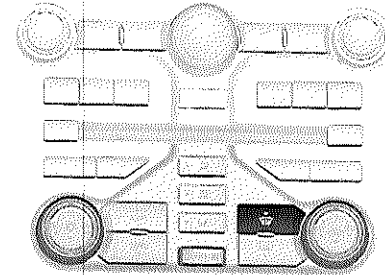

Press button .

Temperature and air distribution are set automatically and the fan runs at high speed.

Press heated rear window button  as needed.

Climate control system ↻ 133.

Transmission

Automatic transmission

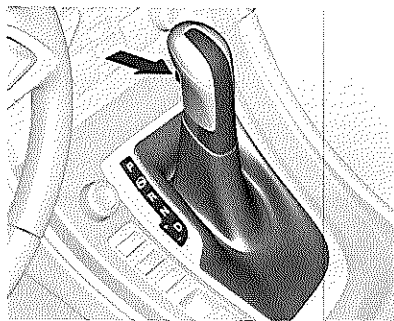

P = Park
R = Reverse
N = Neutral
D = Drive

Manual mode: move selector lever from **D** to the left.

+ = Higher gear
- = Lower gear

On some versions manual mode can be operated with shifters **+ -** on the steering wheel.

The selector lever can only be moved out of **P** when the ignition is on and the brake pedal is applied. To engage **P** or **R**, push the release button.

Automatic transmission ⇨ 146.

Starting Off

Check before starting off or taking a long trip

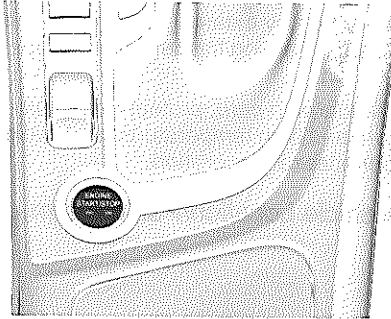

- Tire pressure and condition
⇨ 197.
- Engine oil level and fluid levels
⇨ 172.
- All windows, mirrors, exterior lighting, and number plates are free from dirt, snow, and ice and are operational.
- Proper position of mirrors, seats, and safety belts ⇨ 28, ⇨ 34, ⇨ 43.
- Brake function at low speed, particularly if the brakes are wet.

Starting the Engine



- The remote control needs to be in the passenger compartment.
 - Press and hold brake pedal and move selector lever to **P** or **N**.
 - Push **Start/Stop** button.
- Push button again while engine is running to turn off the engine.
- Starting the Engine ⇨ 144.

Parking

- Always apply parking brake. Pull switch  on the center console.
- If the vehicle is on a level surface or uphill slope, set the selector lever to **P** before turning off the ignition. On an uphill slope, turn the front wheels away from the curb.
If the vehicle is on a downhill slope, set the selector lever to **P** before turning off the ignition. Turn the front wheels towards the curb.
- Lock the vehicle with button  on the remote control. Passive Entry System: Touch the sensor field of the exterior door handle of one of the front doors to lock the vehicle.
Activate the anti-theft alarm system ⇨ 26.
- Do not park the vehicle on an easily ignitable surface. The high temperature of the exhaust system could ignite the surface.
- Close windows.

- The engine cooling fans may run after the engine has been turned off ⇨ 169.
 - After running at high engine speeds or with high engine loads, operate the engine briefly at a low load or run in neutral for approx. 30 seconds, before turning off in order to protect the turbocharger.
- Remote control ⇨ 18, Storing the vehicle for a long period of time ⇨ 166.

Keys, Doors, and Windows

Keys and Locks	18
Doors	24
Vehicle Security	26
Exterior Mirrors	28
Interior Mirrors	30
Windows	30

Keys and Locks Radio Remote Control

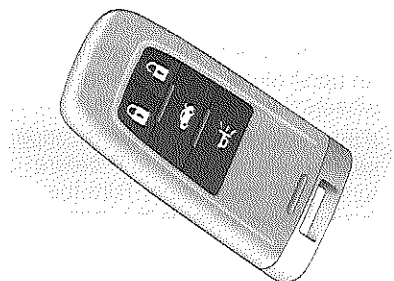

Makes a keyless operation of the following functions possible

- Central Locking System, remote controlled or passive entry function ↻ 20
- Starting the Engine ↻ 144
- Anti-theft alarm system ↻ 26
- Trunk ↻ 24
- Vehicle Location/Panic Alarm

The remote control has an approximate range of up to 164 ft. It can be restricted by external influences. The hazard warning flashers confirm operation.

Handle with care, protect from moisture and high temperatures and avoid unnecessary operation.

Vehicle Location/Panic Alarm

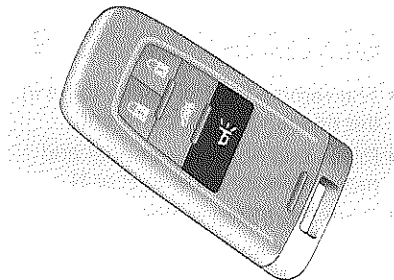



Vehicle Location

Press button  once shortly to locate the vehicle.

This will activate turn indicator and horn 3 times.

Welcome Lighting ⇨ 131

Panic Alarm

Press and hold button  for at least three seconds to activate the panic alarm. The horn sounds and the turn signals flash for 30 seconds or until  is pressed again or the ignition is switched on.

Memorized settings

Whenever the ignition is switched off and the driver's door is opened, the following settings are automatically remembered by the remote control unit:

- Power seats
- Power mirrors
- Head-Up Display (HUD) settings

The saved settings are automatically used the next time the vehicle is unlocked and the ignition is switched on.

Power seats will move to the saved position by unlocking and opening the driver's door.

Precondition is, that **Personalization by driver**, or depending on the display type, **Memory Remote Recall** in the personal settings of the Info-Display is activated. This must be set for each used remote control unit. Vehicle personalization ⇨ 114

Integrated mechanical key

The remote control unit contains an integrated mechanical key which can be used as an emergency key to unlock or lock driver's door, if the remote control or the passive entry system fails.

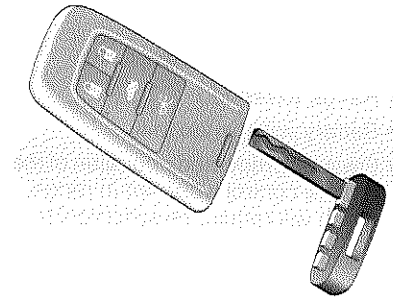

To remove the key, press the button at the bottom of the remote control unit. Extract cap with the key blade out of the remote control. Never pull the key out without pressing the button.

Fault in Remote Control System or Passive Entry System ⇨ 20.

Battery replacement of remote control

Replace the battery as soon as the range reduces. A necessary battery change is indicated as vehicle message in the Driver Information Center (DIC) ⇨ 111.

Caution

When replacing the battery, do not touch any of the circuitry on the transmitter. Static from your body could damage the transmitter.

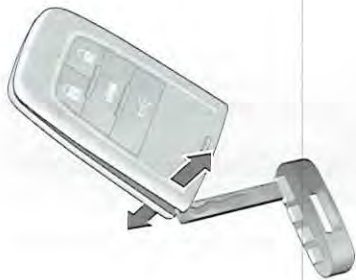

1. Press the button on the remote control and extract the key blade from the housing.
2. Open the unit by using the key blade to separate the two halves of the remote control housing.
3. Replace the battery (battery type CR2032), paying attention to the installation position (positive side facing down). Do not use a metal object.
4. Snap the halves of the housing back together to close the unit.

Synchronize the unit after battery change.

Batteries do not belong in household waste. They must be disposed of at an appropriate recycling collection point.

Synchronization of remote control

After replacing the battery, unlock the door with the mechanical key in the driver's door lock. The remote control will be synchronized when you switch on the ignition.

Fault

If the central locking system does not operate, it may be due to the following:

- Fault in remote control ⇨ 18
- Range exceeded
- Battery voltage too low
- Frequent, repeated operation of the remote control while not in range, which will require re-synchronization

- Overload of the central locking system by operating at frequent intervals, or if the power supply is interrupted for a short time
- Interference from higher-power radio waves from other sources
- Passive entry: remote control out of reception range, change the position of the remote control

Unlocking ⇨ 20.

Replacement remote control unit

The remote control unit number is specified on a detachable tag.

This number must be quoted when ordering replacement remote control unit as it is a component of the immobilizer system.

Central Locking System

Unlocks and locks doors, trunk and fuel filler flap.

A pull on an interior door handle unlocks the respective door. Pulling the handle once more opens the door.

There are two ways to operate the central locking system:

- Remote Control System
- Passive Entry System

Notice

In the event of an accident in which airbags or belt pretensioners are deployed, the vehicle is automatically unlocked.

Remote Control System

Direct the remote control unit to the vehicle.

Unlocking

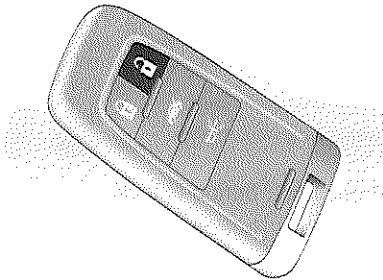

Press button  to unlock all doors, trunk and fuel filler flap,

Locking

Close doors, trunk and fuel filler flap.

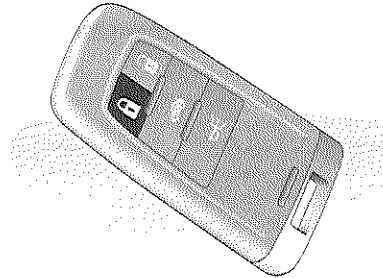

Press button .

If the driver's door is not closed properly, the central locking function will not work.

Passive Entry System

The remote control must be outside the vehicle, within a range of approximately 3 ft.

Unlocking

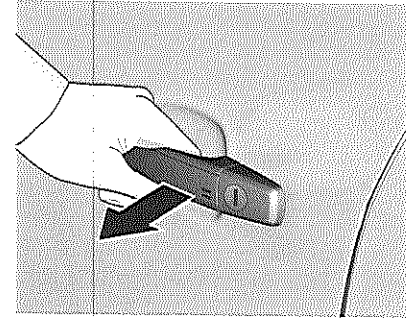

Pull an exterior door handle or press the button under the trunk lid molding. All doors, trunk and fuel filler flap are unlocked.

The thumb may not touch the sensor area on the door handle while unlocking.

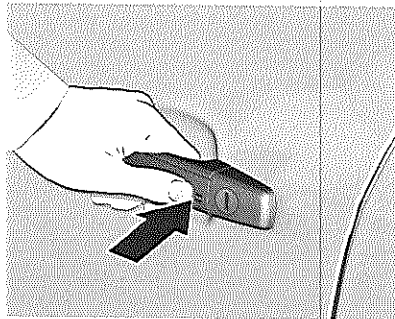
Locking

Touch the sensor field of the exterior door handle on one of the front doors. All doors, trunk and fuel filler flap are locked.

If the driver's door is not closed properly, the central locking system will not work.

3 seconds must pass before the vehicle can be unlocked. Within this time, it is possible to check whether the vehicle is locked.

Notice

The passive entry system does not lock the vehicle automatically.

The sensor fields in the door handles must be kept clean to ensure unrestricted functionality.

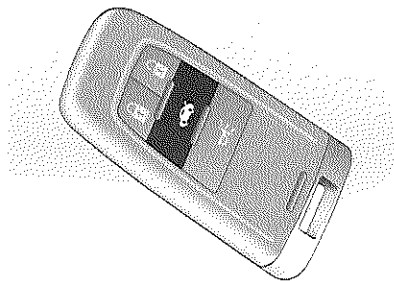
Unlocking and opening the trunk lid

Press button . The trunk lid opens. All other doors remain locked.

Remote Control System: the trunk lid can also be opened manually by pushing the button under the trunk lid molding, if the vehicle has been unlocked with the remote control.

Passive Entry System: to open the trunk lid push the button under the trunk lid molding. All doors will be unlocked.

Central locking buttons in the passenger compartment

Locks or unlocks all doors, the trunk and fuel filler flap from the passenger compartment.

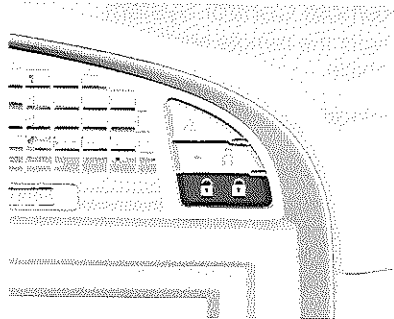

Press the  button to lock.

Press the  button to unlock.

Automatic locking after driving on

This security feature can be configured to automatically lock all doors, trunk and fuel filler flap as soon as the vehicle starts to drive.

Activation or deactivation of automatic locking can be set in the menu **Settings** in the Graphic-Info-Display or **Vehicle** in the Color-Info-Display. Vehicle personalization ↻ 114.

Basic settings

Some settings of the Central Locking System can be changed in the menu **Settings** in the Graphic-Info-Display or **Vehicle** in the Color-Info-Display. Vehicle personalization ↻ 114.

Fault in remote control system or passive entry system

If either the remote control fails or the battery of the remote control is weak, the driver's door can be locked or unlocked with the mechanical key ↻ 18. The Driver Information Center may display **No Remote Detected** or

Replace Battery in Remote Key when you try to start the vehicle. Starting the Engine ↻ 144.

The following instructions are only intended for emergencies. Replace the remote control battery as soon as possible ↻ 18

Unlocking

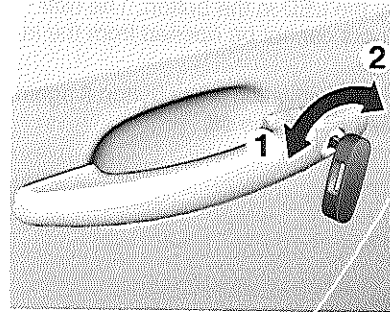

Manually unlock the driver's door by turning the key in the lock, position (1) in figure. Turn on the ignition and press the central locking button  to unlock all doors, trunk and fuel filler flap. On vehicles with anti-theft alarm system, the alarm may be triggered

when the vehicle is unlocked. By turning on the ignition, the alarm is deactivated ↻ 144.

Locking

Press the  button to lock all doors, trunk and fuel filler flap.

Close and manually lock the driver's door by turning the key in the lock, position (2) in figure.

Fault in Central Locking System

Unlocking

Manually unlock the driver's door by turning the mechanical key in the lock, position (1) in figure. The other doors can be opened by pulling the interior handle twice. The trunk and fuel filler flap cannot be opened. On vehicles with anti-theft alarm system, the alarm may be triggered when the vehicle is unlocked. Deactivate the alarm by turning on the ignition ↻ 144.

Locking

Push inside locking knob of all doors except driver's door. Then close the driver's door and lock it from the outside with the mechanical key, position (2) in figure. The fuel filler flap and trunk lid cannot be locked.

Safety Locks

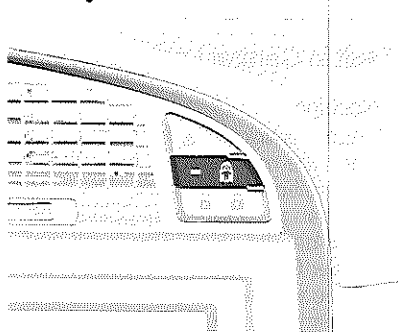

⚠ Warning

Use the child locks whenever children are occupying the rear seats to prevent unintentional opening from the inside.

Press button  to activate child lock on rear doors. Activation is indicated by the LED in the button. The rear doors cannot be opened from the inside.

For deactivation press button  again, the LED will be off.

Doors

Load Compartment

Trunk lid

Opening

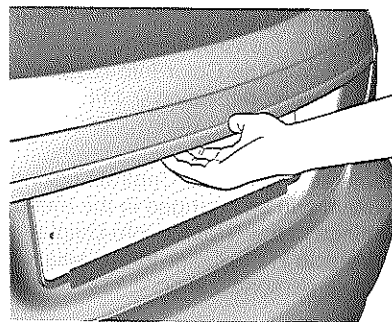

Remote Control System: after unlocking the vehicle by pressing the button  push the button under the trunk lid molding. The trunk lid opens.

Passive Entry System: to open the trunk lid push the button under the trunk lid molding. All doors will be unlocked.

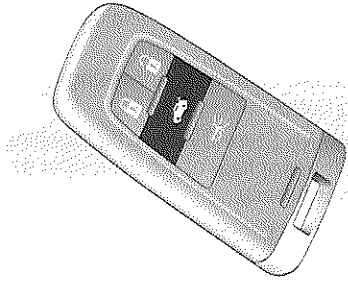

With remote control press button . The trunk lid opens.
Central Locking System ⇨ 20.

Closing

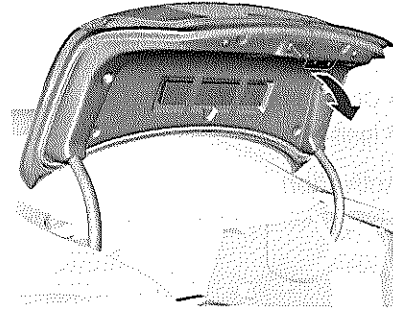

Use the interior handle.
Central Locking System ⇨ 20.

Trunk release handle

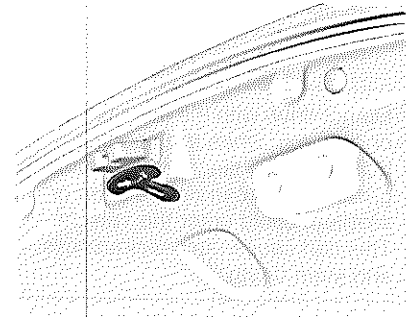

There is an emergency release handle located inside the trunk above the latch of the trunk lid. Pull the handle to open the trunk lid from the inside. The handle will glow following exposure to light.

Caution

The trunk release handle is not designed to be used to tie down the trunk or as anchor point for securing items in the trunk. Improper use of the handle could damage it.

General hints for operating the trunk lid

⚠ Warning

Do not drive with the tailgate open or ajar, e.g. when transporting bulky objects, since toxic exhaust gases, which can not be seen or smelled, could enter the vehicle. This can cause unconsciousness and even death.

Notice

The installation of certain heavy accessories onto the tailgate may affect its ability to remain open.

Vehicle Security

Anti-Theft Alarm System

The anti-theft alarm system monitors:

- Doors, trunk lid, hood
- Ignition

Activation

Close doors, trunk and fuel filler flap.

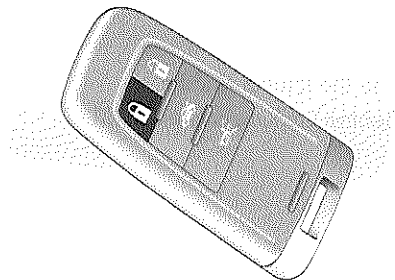

- Self-activated 30 seconds after locking the vehicle (initialization of the system)
- Remote Control: by pressing locking button 
- Passive Entry System: by touching the sensor field of the front door exterior handle.

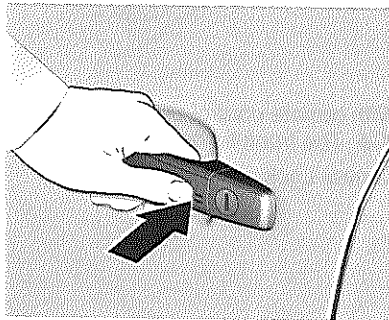

Notice

Changes to the vehicle interior, such as the use of seat covers and open windows, could impair the function of passenger compartment monitoring.

Status LED

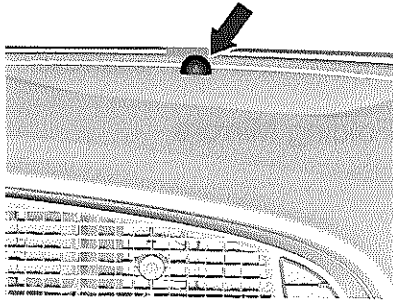

Status LED is integrated in the sensor on top of the instrument panel.

Status during the first 30 seconds of anti-theft alarm system activation:

LED turns on	= test, arming delay.
LED flashes quickly	= doors, trunk lid, or hood not completely closed, or system fault.

Status after system is armed:

LED flashes slowly	= system is armed.
LED flashes quickly 3 times after unlocking	= system is disarmed.

Seek the assistance of a workshop in the event of faults.

Deactivation

Unlocking the vehicle by pressing button  on the remote control or, in case of passive entry system, by pulling the front door exterior handle, deactivates anti-theft alarm system.

Central Locking System  20

Alarm

When triggered, the alarm sounds and the hazard warning lights flash simultaneously. The number and duration of alarm signals are stipulated by legislation.

The alarm can be silenced by pressing any button of the remote control or by turning on the ignition.

The anti-theft alarm system can be deactivated only by pressing button  or by turning on the ignition.

Immobilizer

The system is part of the engine electronics and checks if the vehicle is allowed to be started with the remote control being on the driver's person or in the passenger compartment.

The electronic immobilizer is going to be activated automatically after the ignition has been turned off.

If the control indicator  flashes when the ignition is on, there is a fault in the system; the engine cannot be started. Turn off the ignition and then repeat the start attempt.

If the control indicator continues flashing, attempt to start the engine using the other remote control and seek the assistance of a workshop.

Notice

The immobiliser does not lock the doors. You should always lock the vehicle after leaving it and switch on the anti-theft alarm system ↻ 20, ↻ 26.

Do not leave the remote control unit in the vehicle.

Control indicator 🗉 ↻ 102.

Exterior Mirrors

Convex Mirrors

If equipped, the convex exterior mirror on the passenger side reduces blind spots. The shape of the mirror makes objects appear smaller, which will affect the ability to estimate distances. Because of that, the warning text **OBJECTS IN THE MIRROR ARE CLOSER THAN THEY APPEAR** is printed on the mirror glass.

Power Mirrors

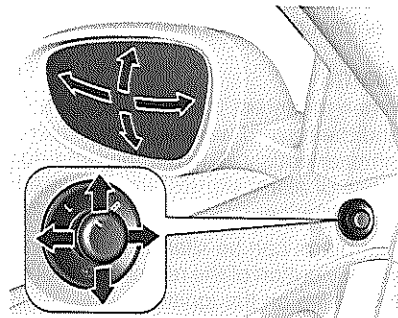

Select the relevant exterior mirror by turning the control to left (L) or right (R). Then swivel the control to adjust the mirror.

In position **O** no mirror is selected.

Folding Mirrors

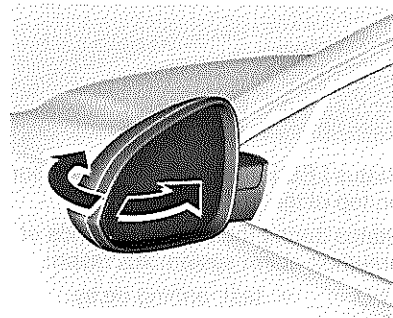

For pedestrian safety, the exterior mirrors will swing out of their normal mounting position if they are struck with sufficient force. Reposition the mirror by applying slight pressure to the mirror housing.

Electric folding

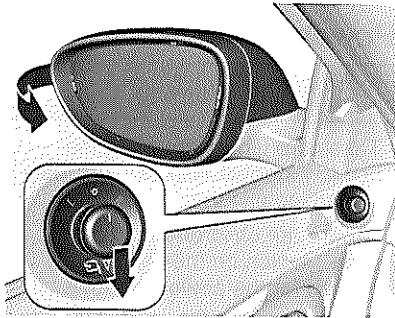

Turn control to **O**, then push the control down. Both exterior mirrors will fold.

Push the control down again - both exterior mirrors return to their original position.

If an electrically folded mirror is manually extended, pressing down the control will only electrically extend the other mirror.

Folding mirrors by remote control

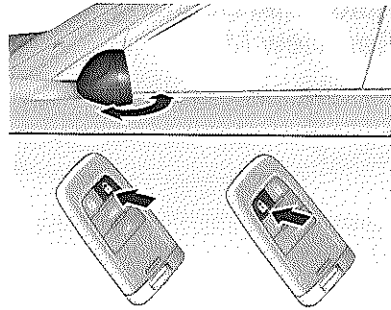

Press and hold **⏪** to fold in mirrors.

Press and hold **⏩** to fold out mirrors.

This function can be activated or deactivated in the menu **Settings** in the Graphic-Info-Display or **Vehicle** in the Color-Info-Display. Vehicle personalization ↻ 114.

Heated Mirrors

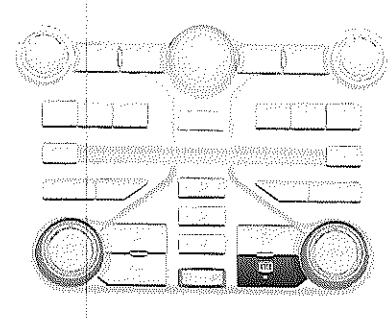

Heated mirrors are operated by pressing the **☀** button.

Heating works with the engine running and is turned off automatically after a short time.

Automatic Dimming Mirror

Glare from following vehicles at night is automatically reduced by dimming both exterior mirrors.

Park Tilt Mirrors

The exterior mirror on the passenger side is automatically aimed at the rear tires as a parking tool when reverse gear is selected.

This function can be activated or deactivated in the menu **Settings** in the Graphic-Info-Display or **Vehicle** in the Color-Info-Display. Vehicle personalization ↻ 114.

Interior Mirrors

Automatic Dimming Rearview Mirror

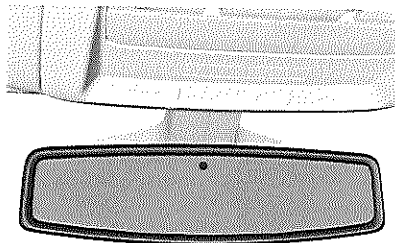

Glare from following vehicles at night is automatically reduced.

Windows

Power Windows

⚠ Warning

Take care when operating the power windows. Risk of injury, particularly to children.

If there are children on the rear seats, switch on the child safety system for the power windows.

Keep a close watch on the windows when closing them. Ensure that nothing becomes trapped in them as they move.

Turn on ignition mode to operate power windows.

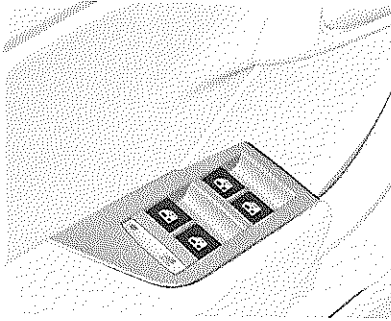

Operate the switch for each window by pushing to open or pulling to close.

Operating front and rear power windows

Pushing or pulling gently to the first detent: window moves up or down as long as the switch is operated.

Pushing or pulling firmly to the second detent and then releasing: window moves up or down automatically with enabled safety function. To stop movement, operate the switch once more in the same direction.

Safety function



If the window glass encounters resistance during automatic closing, it is immediately stopped and opened again.

Override safety function

In the event of closing difficulties due to frost or other obstructions, pull and hold the switch. The window moves up without safety function. To stop movement, release and pull the switch once more.

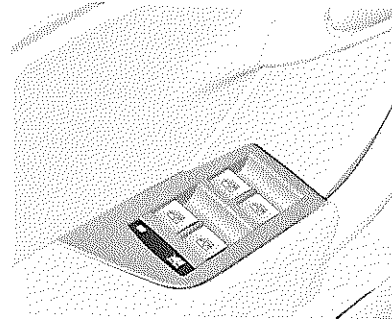
Child safety system for rear windows



Press  to deactivate power switches in the rear doors, the LED turns on. The rear windows are only operable by the switches in the driver's door. To activate, press  again.

Overload

If the windows are repeatedly operated within short intervals, the window operation is disabled for a short time.

Initializing the power windows

If the windows cannot be closed automatically (e.g. after disconnecting the vehicle battery), a warning message is displayed in the Driver Information Center.

Vehicle messages ⇨ 111.

Activate the window electronics as follows:

1. Close doors.
2. Turn on ignition.
3. Open the window completely.

4. Close the window completely and keep the switch pulled for additional 2 seconds.
5. Repeat for each window.

Heated Rear Window

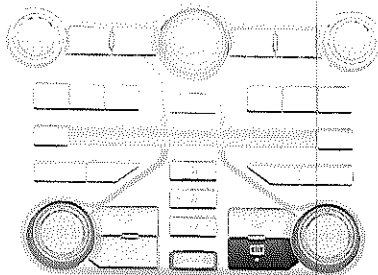

Operated by pressing the  button. Heating works with the engine running and is turned off automatically after a short time.

In the menu **Settings** in the Graphic-Info-Display the function **Auto rear demist** or in the menu **Vehicle** in the Color-Info-Display the function **Auto Rear Defog** can be ac-

tivated or deactivated. This function switches on the rear window heating automatically depending on the outside temperature. Vehicle Personalization \diamond 114.

Automatic rear window demist
 \diamond 133

Sun Visors

The sun visors can be folded down or swiveled to the side to prevent glare.

Sun visors swiveled to the side can be adjusted in length.

If the sun visors have integral mirrors, the mirror covers should be closed when driving.

Seats and Restraints

Head Restraints	33
Front Seats	34
Rear Seats	39
Safety Belts	40
Airbag System	46
Child Restraints	60

Head Restraints

The vehicle's front seats have adjustable head restraints in the outboard seating positions.

The vehicle's rear seats have adjustable head restraints in all seating positions.

Active head restraints on front seats

The front seats are equipped with active head restraints, known as **SAHR 3** system.

In the event of a rear end collision the front part of head restraint is moved forward to support the head, so the risk of neck injury is reduced.

After a collision the head restraint automatically resets to original position.

Position

⚠ Warning

There is a greater chance that occupants will suffer a neck/spinal injury in a collision if the head restraints are not properly installed and adjusted. Do not drive until the head restraints for all occupants are installed and adjusted properly.

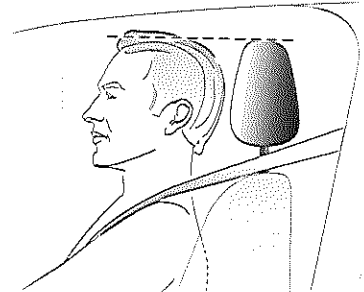

Adjust the head restraint so that the top of the restraint is at the same height as the top of the occupant's head. This position reduces the chance of a neck injury in a crash.

Adjustment

Head restraints on front seats

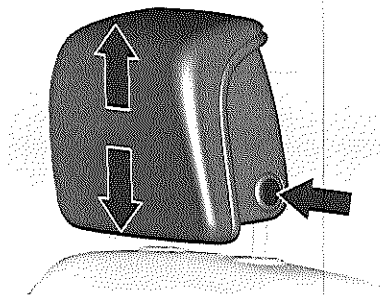

Height adjustment

Press the button, adjust height and engage.

Notice

Approved accessories may only be attached, if the seat is not in use.

Head restraints on rear seats

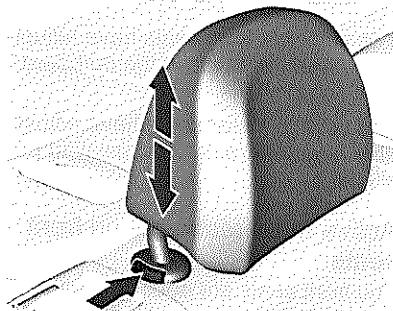

Height adjustment

Pull the head restraint upwards or press the catch to release and push the head restraint downwards.

Remove

To remove rear head restraints press the catch on the right sleeve and press the release on the left sleeve with a steeple object. Pull the headrest upwards. Child restraint installation locations ↻ 67.

Front Seats

Seat Position

⚠ Warning

Only drive with the seat correctly adjusted.

Never adjust the driver's seat while driving as this could cause you to lose control.

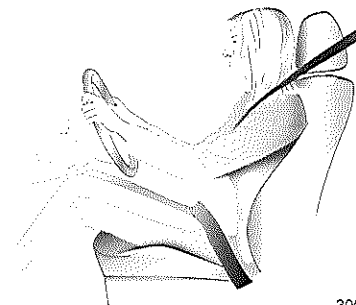

30050

- Sit with lower back as far back against the backrest as possible. Adjust the distance between the

- seat and the pedals so that legs are slightly angled when pressing the pedals.
- Slide the front passenger seat as far back as possible while maintaining correct position for the safety belt ⇨ 40.
 - Sit with shoulders as far back against the backrest as possible. Set the backrest rake so that it is possible to easily reach the steering wheel with arms slightly bent. Maintain contact between shoulders and the backrest when turning the steering wheel. The backrest should be adjusted to allow an upright driving position.
 - Adjust the steering wheel ⇨ 88.
 - Adjust the backrest to an upright position, so that the safety belt, air-bag and backrest can provide optimum protection in the event of emergency braking or a crash.
 - Set seat height high enough to have a clear field of vision on all sides and of all display instruments. Your thighs should rest lightly on the seat without pressing into it.
- Adjust the head restraint ⇨ 33.
 - Adjust the height of the safety belt ⇨ 43.
 - Adjust the thigh support so that there is a space approx. two fingers wide between the edge of the seat and the hollow of the knee.
 - Adjust the lumbar support so that it supports the natural shape of the spine.

Power Seat Adjustment

⚠Warning

Care must be taken when operating the power seats. The seats are actuated by powerful motors. There is a risk of injury, particularly for children. Articles could become trapped.

Never leave the remote control in the vehicle when leaving the vehicle! Risk of injury to unsupervised persons in event of power seat adjustment.

Bear in mind that children could be injured if they play with the power seats.

Keep a close watch on the seats when adjusting them. Vehicle passengers should be informed accordingly.

⚠ Danger

Do not sit nearer than 10 inches to the steering wheel, to permit safe airbag deployment.

Caution

When adjusting seat height, make sure that the head restraint is so adjusted, that the roof panel is not damaged.

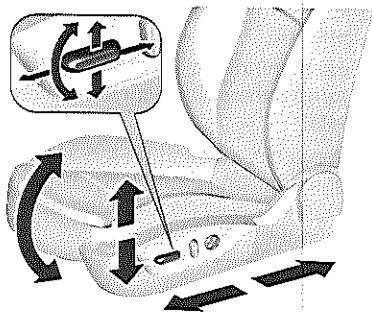
**Legroom positioning**

Move switch forwards/backwards.

Seat height adjustment

Move switch upwards/downwards at rear.

Seat inclination adjustment

Move switch upwards/downwards at front.

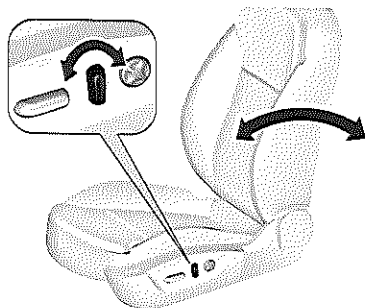
Seat backrests adjustment

Turn switch forwards/backwards.

⚠ Warning

The backrest should be upright during driving, so that the safety belt, airbag and backrest can provide optimum protection in the event of emergency braking or a collision, in particular a rear-end collision.

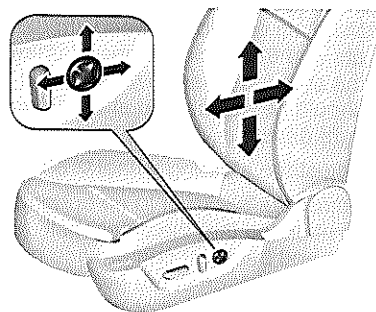
Lumbar support

Adjust lumbar support using four-way switch to suit personal requirements.

Moving support up and down: push switch up or down. Increasing and decreasing support: push switch forwards or backwards.

Adjustable thigh support

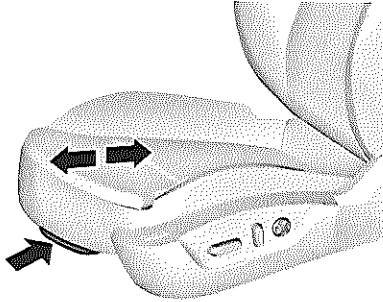

Pull the lever and slide the thigh support.

Memory function for front power seats adjustment and exterior mirrors

Two different seat and mirror settings can be stored.

Memorized settings ⇨ 18, Vehicle personalization ⇨ 114.

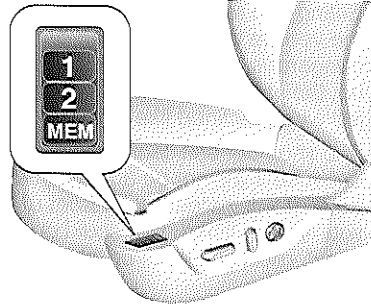

Storing settings

- Adjust driver seat first and then exterior mirrors.
- Keep memory button **MEM** pressed and then press position button to be used (1 or 2). Storage is acknowledged by an acoustic signal.

Retrieving settings

- Keep position button 1 or 2 pressed until the stored seat and mirror positions have been reached.

Overload

If the seat setting is electrically overloaded, the power supply is automatically cut off for a short time.

⚠ Warning

The legroom of the power driver's seat can always be adjusted, regardless of whether a front door is open or the ignition is on.

Notice

After an accident in which airbags have been deployed, the position buttons will be deactivated.

Reclining Seatbacks

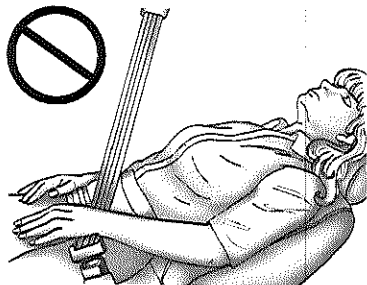

⚠ Warning

Sitting in a reclined position when the vehicle is in motion can be dangerous. Even when buckled up, the safety belts cannot do their job when reclined like this.

The shoulder belt cannot do its job because it will not be against your body. It will instead be in front of you. In a collision, you could go into it, receiving neck or other injuries.

The lap belt cannot do its job either. In a collision, the belt could go up over your abdomen. The belt forces would be there, not at your pelvic bones. This could cause serious internal injuries.

For proper protection when the vehicle is in motion, have the backrest upright. Then sit well back in the seat and wear the safety belt properly.

Armrest

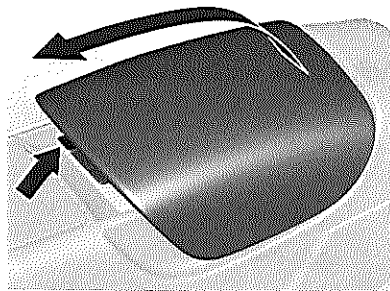



Push right button to swivel armrest front- or rearwards.

Under the armrest there is a storage compartment ⇄ 80.

Auxiliary devices, see description for Infotainment system.

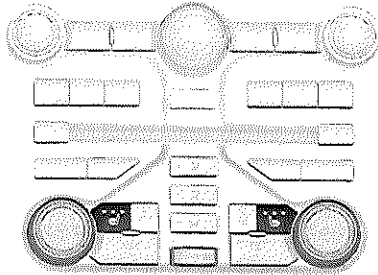
Heated Front Seats



Adjust seat heating to the desired setting by pressing the  button for the respective front seat one or more times in **Ignition on** mode. The control indicator in the button indicates the setting.

Prolonged use of the highest setting for people with sensitive skin is not recommended.

Seat heating is operational when engine is running.

Seat heating and seat ventilation cannot be used simultaneously.

Ventilated Front Seats

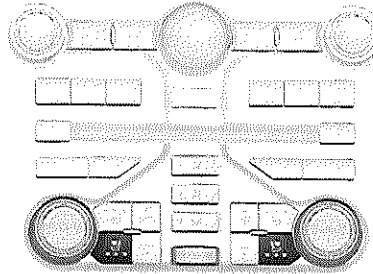

Adjust seat ventilation to the desired setting by pressing the  button for the respective front seat one or more times in **Ignition on** mode.

The control indicator in the button indicates the setting.

Ventilated front seats are operational when engine is running.

Seat ventilation and seat heating cannot be used simultaneously.

Rear Seats

Armrest

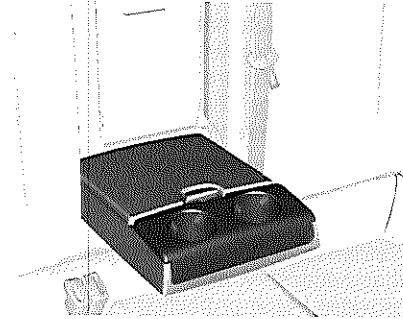

Fold armrest down. The armrest contains cupholders and a storage box.

Safety Belts

The safety belt will allow the wearer freedom of movement. The retractor will lock up automatically if the belt is jerked or withdrawn sharply, the car tilts, the brakes are applied hard or a crash occurs. Thereby the risk of injury is considerably reduced.

Check to ensure that the belt is not twisted or rubbing against any sharp edges.

Refrain from tilting the backrest more than necessary, as the safety belt provides better protection when the seat is in the more upright position.

Three-point inertia-reel safety belts are provided for all seats. The results of studies show that it is equally important to wear safety belts in the rear seat as in the front seats.

⚠ Warning

Buckle up and adjust your safety belt before driving off so that you can pay full attention to the traffic.

Safety belts must be worn at all times by all occupants.

Child safety, ⇨ 60.

Check that the locking tongue is properly locked in the belt buckle.

In the event of a collision, a rear-seat passenger not wearing a safety belt will be thrown forward against the front-seat backrests.

The stresses imposed on the front seat passengers and belts are multiplied and could result in injury or even death for all car occupants.

Safety belts are designed to be used by only one person at a time.

Periodically check all parts of the belt system for damage and proper functionality as follows:

Hold the diagonal strap and pull it sharply. The safety belt should lock and it should not be possible to withdraw it further. Check the anchorage points in the floor. They should be free from rust damage. If a belt is worn or has any fraying edges, it should be replaced. Safety belts must not come into contact with substances such as polishes, oil or chemicals. If the belts get dirty, wash them with warm water and a mild detergent or have them replaced.



⚠ Danger

If the car is involved in a crash, the safety belts, belt tensioners, airbags and other components must be inspected, preferably by your authorized dealer and replaced as necessary.

Never make alterations or repairs to the safety belts and airbags yourself. It is recommended that you visit your authorized dealer for any necessary repairs.

Notice

Make sure that the belts are not trapped or damaged by shoes or sharp-edged objects. Prevent dirt from getting into the belt retractors.

Safety belt reminder   98.

Correct position for safety belt**Warning**

Proper positioning of the safety belt is extremely important.

- An out-of-position safety belt could result in the wearer sliding underneath the belt in a collision (submarining). This, in turn, could result in injury from the lap belt cutting into the abdomen.
- **Never** fasten the safety belt with the shoulder belt behind the body or pull the belt off the shoulder and position it under the arm.
- Two people must never share one safety belt. In the event of a collision, those sharing a belt risk being crushed together and injured.

Consider this:

- Position the lap strap snugly and low across the hips so that it just touches the thighs. The shoulder strap must be as far in on the shoulder as possible.

- Check to ensure that the belt is not twisted or rubbing against any sharp edges.
- There should not be any slack in the belt. Pull the belt tight - particularly important when thick outer clothing is worn. It is advisable to remove thick items of clothing.
- Refrain from tilting the backrest more than necessary, as the safety belt provides better protection when the seat is in the more upright position.
- Only one person per safety belt!
- For most of the time a safety belt is worn, the retractor will allow the wearer freedom of movement. The retractor locks up automatically if the belt is jerked or withdrawn sharply, the car tilts, the brakes are applied hard or a crash occurs.
- Children up to 6 years of age must always be seated in a child seat. Saab recommends the use of a child seat for children up to the age of 10. Use a child seat that is approved for the child's weight and height.

- Children who have grown out of a child seat should be restrained by the car's standard three-point belts. Make sure that the shoulder belt is not in contact with the neck or throat. If it is, a booster seat/cushion may be necessary.

Rear Safety Belt Comfort Guides

This vehicle may have rear shoulder belt comfort guides. If not, they are available through your dealer. The guides may provide added safety belt comfort for older children who have outgrown booster seats and for some adults. When installed and properly adjusted, the comfort guide positions the belt away from the neck and head.

There is one guide for each outside passenger position in the rear seat. Here is how to install a comfort guide to the safety belt:

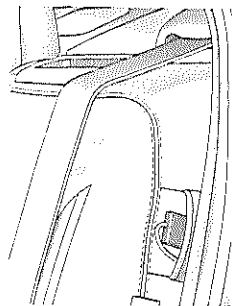

1. Remove the guide from its storage pocket on the side of the seat.

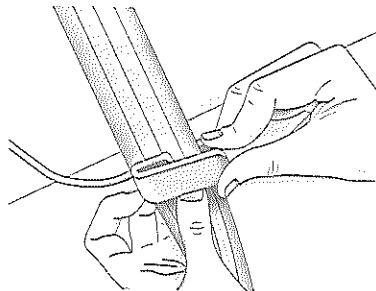

2. Place the guide over the belt, and insert the two edges of the belt into the slots of the guide.

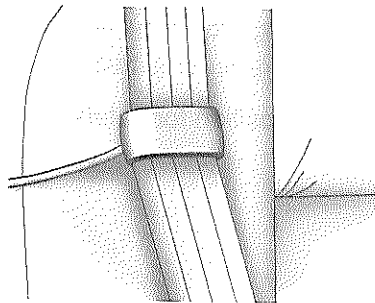

3. Be sure that the belt is not twisted and it lies flat. The elastic cord must be under the belt and the guide on top.

⚠ Warning

A safety belt that is not properly worn may fail to provide the protection needed in a collision. The person wearing the belt could be seriously injured. The shoulder belt should lie over the shoulder and across the chest. These parts of the body are best able to take belt restraining forces.

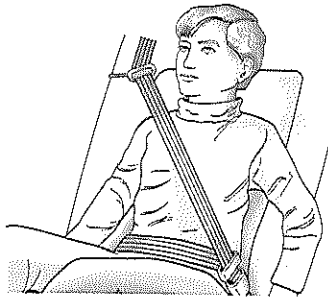

4. Buckle, position, and release the safety belt as described previously in this section. Make sure the shoulder portion of the belt is

on the shoulder and not falling off it. The belt should be close to, but not touching, the neck.

Belt pretensioners

In the event of a collision of a certain severity, the front safety belts and rear outer safety belts are tightened.

⚠ Warning

Incorrect handling (e.g. removal or fitting of belts) can trigger the belt pretensioners.

Deployment of the belt pretensioners is indicated by illumination of control indicator  98.

Belt pretensioners can only be triggered once.

Notice

Do not affix or install accessories or other objects that may interfere with the operation of the belt pretensioners.

Belt force limiters

On the front seats and outer rear seats, stress on the body is reduced by the gradual release of the belt during a collision.

Three-Point Safety Belt

All seating positions in the vehicle have a three point safety belt.

Fastening

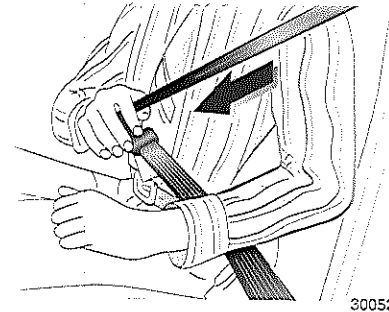

Withdraw the belt from the retractor, guide it untwisted across the body and insert the latch plate into the buckle. Position the lap strap tightly

and low across the hips so that it just touches the thighs. The shoulder strap must be as far in on the shoulder as possible. Tighten the lap strap regularly while driving by pulling the shoulder belt.

Safety belt reminder ⇨ 98

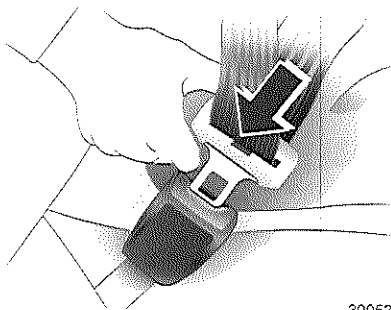

30053

Loose or bulky clothing prevents the belt from fitting snugly. Do not place objects such as handbags or mobile phones between the belt and your body.

⚠ Warning

The belt must not rest against hard or fragile objects in the pockets of your clothing.

Height adjustment

Adjust the belt so that it is as high up as possible without rubbing against the neck. To avoid chafing in the case of a short person, the guide can be lowered until the belt comes about a few centimeters from the neck but still provides safe restraint.

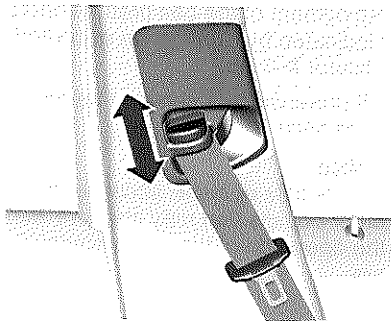

1. Pull belt out slightly.
2. Press button.
3. Adjust height and engage.



Do not adjust while driving.

Removing



30054

To release belt, press red button on belt buckle.

Safety belts on the rear seats

The safety belt for the rear center seat can only be withdrawn from the retractor if the backrest is in the upright position.

Make sure that the backrests are locked ⇨ 82.

⚠ Warning

Make sure that the belt does not become trapped when the backrest is folded down or raised ⇨ 82.

If cargo has to be placed on a seat, it must be properly secured with the safety belt. This reduces the risk of the cargo being thrown about during hard braking or a collision, which could cause personal injury.

Check that the belt is not twisted or lying against sharp edges.

Make sure you use the correct belt buckle. The buckles for the center and left-hand rear seats are close together.

Safety belt use during pregnancy



Pregnant women must always wear a safety belt to protect both themselves and the unborn child.

⚠ Warning

The lap belt must be positioned low, across the hips and over the upper thighs, so that pressure is not put on the abdomen.

Airbag System

⚠ Warning

To reduce the risk of death or serious injury:

Always wear your safety belt.

Always adjust your seat so that you are as far back as possible but still able to operate the pedals and reach the steering wheel and controls comfortably.

Passengers shorter than 4 ft 7 in must always travel in the rear seat if the car is equipped with a passenger airbag.

Never install a child seat in front of the passenger airbag.

Airbags are designed to supplement the protection provided by safety belts. Even though today's airbags are also designed to help reduce the risk of injury from the force of an inflating bag, all airbags have to inflate very quickly to do their job.

When triggered the airbags inflate within milliseconds. They also deflate so quickly that it is often unnoticeable during the collision.

⚠ Warning

If handled improperly the airbags may inflate unexpectedly.

⚠ Danger



If the car is involved in a crash, the safety belts, belt tensioners, airbags and other components must be inspected, preferably by your authorized dealer and replaced as necessary.

Never make alterations or repairs to the safety belts and airbags yourself. It is recommended that you visit your authorized dealer for any necessary repairs.

Notice

Do not stick anything on the airbag covers and do not cover them with other materials.

Each airbag is triggered only once.

Control indicator  for airbag systems  98.

Seat occupancy recognition  57.



⚠ Warning

- All car occupants must always wear a safety belt, even if the car is equipped with airbags.
- Note that because the front and side airbags inflate and deflate extremely quickly, it will not provide protection against a second impact occurring in the same incident. Always wear your safety belt. The curtain airbag is also designed to deploy in roll-over events. It is therefore inflated during a longer period of time and will give some protection during a second impact occurring in the same incident, but is

still only complementary to the use of a properly worn safety belt.

- Always sit with the whole of your back in contact with the backrest of the seat and with your seat as far back as is practical. Otherwise you will be thrown back against the backrest when the airbag inflates, which could cause you injury or death. The airbag needs room in which to inflate.
- Some components of the airbag will be warm for a short time. In some circumstances, the airbag can cause minor burns or abrasions to the body when inflating/deflating.
- Fumes are generated by the chemical reaction that inflates the airbag. Skin surfaces that show signs of irritation should be washed with clean water and a mild soap as soon as possible. In the event of eye irritation, flush the eyes thoroughly with

clean water for at least 20 minutes. In case of persistent irritation, consult a doctor.

- Never attach anything to the steering wheel, headliner, pillar trims or passenger side instrument panel as this could cause personal injury when an airbag inflates. The same applies to anything you might have in your mouth, such as a pipe.
- Never rest your hands or forearms on the steering wheel center padding where the airbag is located.
- If the airbag indicator light  in the main instrument panel does not extinguish after the car has been started, or comes on or flashes while driving, have the car checked immediately. We recommend that you contact an authorized Saab workshop. When illuminated, the airbag indicator light  indicates that the

system may fail to function in a collision or could even inflate without a collision.

Airbag system components

- Airbag in steering wheel
- Airbag in instrument panel in front of passenger seat
- Side airbags in front seat backrests
- Inflatable curtains along length of headlining (from front to rear roof pillars)
- Safety belt pretensioners for front seats
- Safety belt pretensioners and side airbags for rear outboard seats.

The airbag system supplements the protection provided by the safety belts to further enhance the safety of occupants taller than 4 ft 7 in.

When the system is activated at the moment of impact, the airbag inflates and then deflates through holes in the back. The whole operation takes roughly 0.1 second, quicker than the blink of an eye.

The steering wheel and passenger airbags are known as smart airbags.

There are two impact sensors on the front upper beam. Very soon after the moment of impact, these register that the car is involved in a crash. Using this information and data from the central sensor in the control module, the control module determines whether or not to inflate the airbags. The control module also controls whether other components of the airbag system are to be deployed: safety belt pretensioners & inflatable curtains. Which airbag system components are deployed depends on a number of factors, such as the force of the crash and the angle of impact.

If the airbag system registers forces equivalent to a high-speed crash, the inflatable curtains will also be activated.

If a fault arises in the airbag system during a journey, the airbag control indicator  on the main instrument panel will come on.

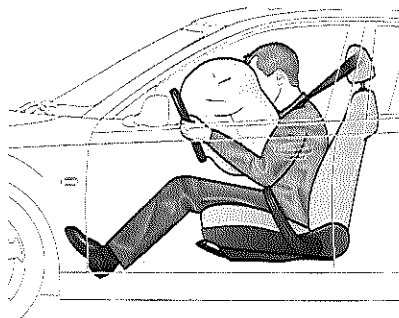

The driver and passenger front airbags are triggered by violent front-end crashes. They are not activated by minor front-end impacts, if the car overturns or by rear and side-impacts.

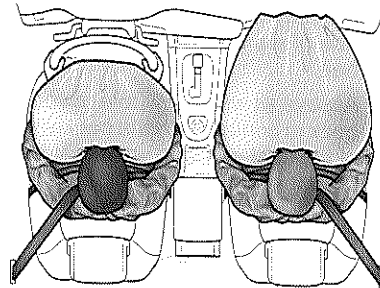

Notice

If only Stage I is activated at the moment of impact, Stage II will automatically be activated later to neutralize the gas generator in the airbag.

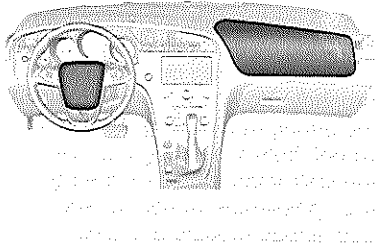

Accessories and other equipment must not be fitted to the surfaces marked as these are where the airbags inflate in the event of a crash.

When the airbag system is activated all of the doors are unlocked while the interior/exterior lighting and the hazard warning lights are illuminated at the same time.

Airbag control indicator

There is an airbag control indicator on the instrument panel cluster, which shows the airbag symbol. The system checks the airbag electrical system

for malfunctions. The light tells you if there is an electrical problem. Airbag control indicator  98

Warning

If the airbag indicator light stays on after you start your vehicle, it means the airbag system may not be working properly.

The airbags in your vehicle could fail to inflate in a collision or they could even inflate without a collision.

To help prevent injury to yourself or others, have your vehicle serviced right away if the airbag indicator light stays on after you start your vehicle.

What Will You See After an Airbag Inflates?

After an airbag inflates, it quickly deflates, so quickly that some people may not even realize the airbag inflated. Some components of the airbag module - the steering wheel hub for the driver's frontal airbag, the instru-

ment panel for the right front passenger's frontal airbag or the ceiling of your vehicle near the side windows - will be hot for a short time. The parts of the bag that come into contact with you may be warm, but not too hot to touch. There will be some smoke and dust coming from the vents in the deflated airbags. Airbag inflation does not prevent the driver from seeing or being able to steer the vehicle, nor does it stop people from leaving the vehicle.

⚠ Warning

When an airbag inflates, the air is filled with dust. This dust could cause breathing problems for people with a history of asthma or other breathing trouble. To avoid this, everyone in the vehicle should get out as soon as it is safe to do so. If you have breathing problems but cannot get out of the vehicle after an airbag inflates, then get fresh air by opening a window or a door. If you experience breathing problems following airbag deployment, seek medical attention.

In many crashes severe enough to inflate an airbag, windshields are broken by vehicle deformation. Additional windshield breakage may also occur from the right front passenger airbag.

- Airbags are designed to inflate only once. After an airbag inflates, you will need some new parts for your airbag system. If you do not get

them, the airbag system will not be there to help protect you in another crash. A new system will include airbag modules and possibly other parts. The service manual for your vehicle covers the need to replace other parts.

- Your vehicle is equipped with a crash sensing and diagnostic module which records information after a crash. See Vehicle Data Collection and Event Data Recorders ◊ 234.
- Let only qualified technicians work on your airbag system. Improper service can mean that your airbag system will not work properly. See your dealer for service.

Notice

If you damage the covering for the driver's or the right front passenger airbag, or the side impact airbag covering on the ceiling near the side windows, the bag may not work properly. You may have to replace the airbag module in the steering wheel, both the airbag module and the instrument panel for the right front passenger airbag, or side impact airbag module and ceiling covering for the ceiling-mounted side impact airbag. Do not open or break the airbag coverings.

Servicing the airbag system

The airbag system must be inspected as part of the normal service program but otherwise may be regarded as maintenance-free.

Scrapping or working on airbag and belt pretensioners

⚠ Warning

- Under no circumstances should any modifications be made that affect the steering wheel or the airbag's electrical circuitry.
- During any welding, **both** battery cables must be disconnected and covered.
- Before applying quick-drying paint in the vicinity of the electronic control module, the module's grounding points and wiring must be covered.
- Airbags and safety belt pretensioners must be deployed under controlled conditions before the car is scrapped or any of the system's components are removed. Airbags or belt pre-

ensioners that have been deployed as a result of a collision must be replaced by new ones.

- The car's impact protection consists of several different safety features, including the airbags, safety belts, steering wheel, seats and dashboard. These parts are coordinated with each other to provide optimum protection in the event of a collision, so never install an airbag from one car into another. There is no guarantee that it would then work satisfactorily in the event of a collision.
- All work involving the scrapping or replacement of airbags or belt pretensioners must be carried out by authorized personnel only.

Frequently asked questions on function of the airbag

- ② Do you still need to wear a safety belt if airbags are fitted?
- ① Yes, always! The airbag system components merely supplement the car's normal safety system. Moreover, the front airbags will only be actuated in a moderate to severe frontal, or near-frontal crash, which means, of course, that they provide no protection in minor frontal crashes, major rear or side crashes or if the car rolls over.

In addition, airbags provide no protection against a secondary impact occurring in the same incident. So there is no doubt about the benefit of wearing safety belts at all times.

Do not sit too close to the airbag: it needs room to inflate.

The airbag inflates very quickly and powerfully in order to protect an adult, before they are thrown forward, in a serious frontal crash.

② **How do I position the seat to leave room for the airbag to inflate?**

- ① Don't have your seat too far forward.

Airbags inflate extremely rapidly and with great force - to be fast enough to protect an adult in the seat.

② **When do the airbags in the steering wheel and passenger side of the dashboard inflate?**

- ① The airbag will only be inflated under certain predetermined conditions in a moderate to severe frontal, or near-frontal crash, depending on such factors as the force and angle of the impact, the speed of the car on impact, and the resistance to deformation of the impacting object.

The airbag can only be activated once in the same incident.

Do not attempt to drive the car after an airbag has been inflated, even if it is possible.

② **What won't trigger the airbag?**

- ① The airbag will not be activated in all frontal crashes. For instance, if the car has hit something relatively soft and yielding (e.g. a snow drift or a hedge) or a solid object at a low impact speed, the airbag will not necessarily be triggered.

② **How loud is the inflation?**

- ① The noise of the inflation is certainly loud, but it is of a very short duration and will not damage your hearing. For a short time afterwards you could experience a buzzing noise in your ears.

Most people who have experienced it cannot remember the noise of the inflation at all - all they remember is the noise of the crash.

② **Can you still use a child seat in the front if a passenger airbag is installed?**

- ① Definitely not! Children 12 and under or shorter than 4 ft 7 in can be killed by the airbag.

The rear seat is the safest place for children.

Seat occupancy recognition

⇨ 57

② **What should I do if the AIRBAG control indicator comes on?**

- ① If the warning light is on, it means that a fault has been detected in the system. The airbag cannot be relied on to operate as intended and it might even be activated erroneously. You should therefore take the car to a workshop. We recommend that you contact a Saab dealer as soon as possible.

② **Are the dust and fumes given off when the airbag operates at all harmful?**

- ① Most people who have remained in a car with little or no ventilation for several minutes complained only of minor irritation of the throat and eyes. Avoid as much as possible getting dust on your skin as there is a risk of skin irritation.

If you suffer from asthma, the incident may bring on an attack, in which case you should follow the normal procedure advised by your doctor. It is advisable to consult a doctor afterwards.

Adding Equipment to Your Airbag-Equipped Vehicle

- ② **Is there anything I might add to the front or sides of the vehicle that could keep the airbags from working properly?**
- ① Yes. If you add things that change your vehicle's frame, bumper system, front end or side sheet metal or height, they may keep the airbag system from working properly. Also, the airbag system may not work properly if you relocate any of the airbag sensors. If you have any questions about this, you should contact Saab Customer Assistance before you modify your vehicle. Phone numbers and addresses for Customer Assistance ⇨ 233.

② **Because I have a disability, I have to get my vehicle modified. How can I find out whether this will affect my advanced airbag system?**

- ① Changing or moving any parts of the front or rear seats, safety belts, the airbag sensing and diagnostic module or the inside rearview mirror can affect the operation of the advanced airbag system. If you have questions, call Customer Assistance. Phone numbers and addresses for Customer Assistance ⇨ 233.

Front Airbag System

The front airbag system consists of one airbag in the steering wheel and one in the instrument panel on the front passenger side. These can be identified by the word **AIRBAG**.

There is also an **AIRBAG** warning label on the front of each sun visor.

⚠ Warning

Never secure a rear-facing child seat in the right front seat of a car equipped with a passenger airbag. Inflation of the airbag in the event of a collision could seriously injure or kill a child.

The front airbag system is triggered in the event of a front-end impact of a certain severity. The ignition needs to be switched on.

The car is equipped as standard with a passenger airbag.

In a frontal collision of a certain severity the curtain airbags will also be triggered ⇨ 56.

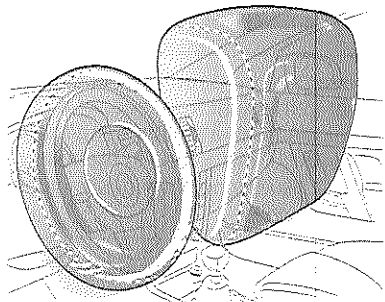

The inflated airbags cushion the impact, thereby reducing the risk of injury to the upper body and head of the front seat occupants.

⚠ Warning

- Children can be killed or seriously injured by the airbag.
- The rear seat is the **SAFEST** place for children 12 and under or shorter than 4 ft 7 in.
- **ALWAYS** use SAFETY BELTS and CHILD RESTRAINTS.
- **NEVER** put a rear-facing child seat in the front.
- Position the seat as far back from the airbag as possible.
- Never allow a child to stand in front of the seat or to sit on the lap of a front seat passenger.

Serious injury or death could occur if the airbag is inflated in a collision.

- The glove compartment must be closed while travelling. An open glove compartment lid could cause leg injuries in the event of a collision.
- Never place anything on the dashboard or in front of the seat. In addition to being a hazard to passengers, this could interfere with the function of the airbag in the event of a collision. The same applies to the mounting of accessories on the dashboard.
- Keep your feet on the floor - never put your feet up on the dashboard, on the seat or out of the window.
- Do not carry anything in your lap.

Side Airbag System

The side airbag system consists of an airbag in each front seat backrest and in the rear outboard seat backrests. This can be identified by the label **AIRBAG**.

The side airbag system is triggered in the event of a side impact of a certain severity. The ignition needs to be switched on.

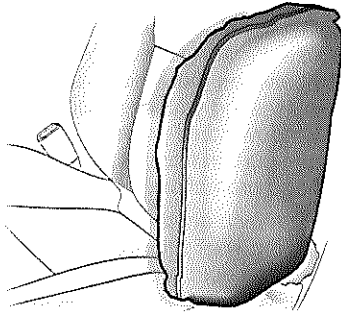

The inflated front side airbags cushion the impact, thereby reducing the risk of injury to the upper body and pelvis in the event of a side-on collision.

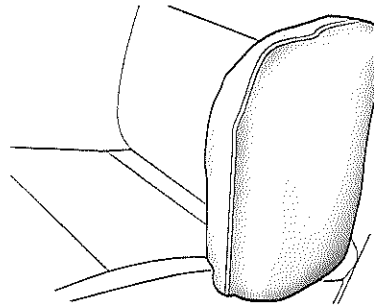
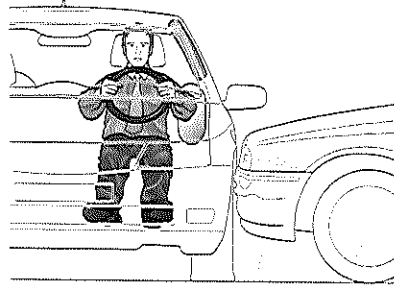

The inflated rear side airbags cushion the impact, thereby reducing the risk of injury to the upper body in the event of a side-on collision.

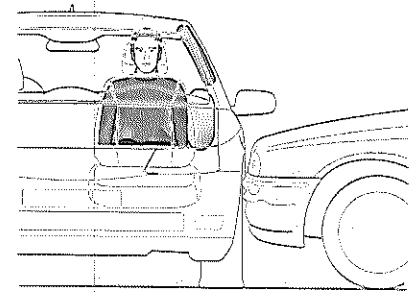

For optimum protection, sit upright in the seat, with your safety belt correctly fastened.

⚠ Warning

- Keep the area in which the airbag inflates clear of obstructions.
- Never install extra seat covers. Seat covers can prevent the side airbags from inflating correctly and thus not provide the intended protection.

The side-impact protection will only be activated in the event of a side-on crash and not in the event of a frontal collision or the car rolling over.

Damage or wear to the seat cover, or the seat seam, in the area of the side airbag must be repaired immediately. We recommend that you contact a Saab dealer.

Curtain Airbag System

The curtain airbag system consists of an airbag in the roof frame on each side. This can be identified by the label **AIRBAG** on the roof pillars.

The curtain airbag system is triggered in the event of a side, front or rollover impact of a certain severity. The ignition needs to be switched on.

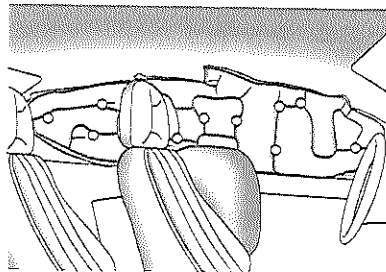

The inflated airbags cushion the impact, thereby reducing the risk of injury to the head in the event of a side, front or rollover impact.



⚠ Warning

Keep the area in which the airbag inflates clear of obstructions.

The hooks on the handles in the roof frame are only suitable for hanging up light articles of clothing, without coat hangers. Do not keep any heavy or sharp objects in these clothes.

Do not sit with your head rested against the side window. The inflatable curtain is designed to inflate between the window and the head. Resting your head against the window could prevent the inflatable curtain from providing the intended protection.

Do not attach anything to the car's headlining, roof pillars or side panels as this could prevent the roof-rail airbag from providing the intended protection.

Do not position a sun visor or similar item in the area that would be filled by the inflatable curtain.

Do not stack loads so high that they could encumber the inflatable curtain in the event of a collision.

Seat Occupancy Recognition

Passenger Sensing System

Vehicles with a passenger sensing system have indicator LEDs on the roof console. The indicators will both be lit during the system check when the ignition is switched on. When the system check is complete, either the symbol for **on** or **off** will be lit.

The passenger sensing system will turn off the right front passenger's frontal airbag under certain conditions.

The driver's airbags are not part of the passenger sensing system.

The passenger sensing system works with sensors that are part of the right front passenger's seat and safety

belt. The sensors are designed to detect the presence of a properly-seated occupant and determine if the passenger's frontal airbag should be enabled or not.

Accident statistics show that children are safer if they are restrained in the rear rather than the front seat.

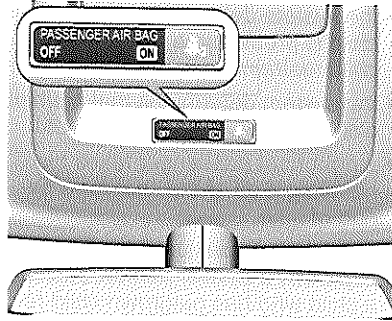

Saab recommends that child restraints be secured in a rear seat, including: an infant riding in a rear-facing infant seat; a child riding in a forward-facing child seat; an older child riding in a booster seat; and children, who are large enough, using safety belts.

Your vehicle has a rear seat that will accommodate a rear-facing child restraint. Never put a rear-facing child seat in the front. This is because the risk to the rear-facing child is so great, if the airbag deploys.

⚠ Warning

A child in a rear-facing child restraint can be seriously injured or killed if the right front passenger airbag inflates. This is because the back of the rear-facing child restraint would be very close to the inflating airbag.

Even though the Passenger Sensing System is designed to deactivate the passenger frontal airbag if the system detects a rear-facing child restraint, no system is fail-safe. No one can guarantee that an airbag will not deploy under some unusual circumstance, even though it is deactivated. Saab recommends that rear-facing child restraints be secured in the rear seat, even if the airbag is deactivated.

The passenger sensing system is designed to turn off the right front passenger's frontal airbag if:

- the right front passenger seat is unoccupied
- the system determines that an infant is present in a rear-facing infant seat
- the system determines that a small child is present in a forward-facing child restraint
- the system determines that a small child is present in a booster seat
- a right front passenger takes his/her weight off of the seat for a period of time
- the right front passenger seat is occupied by a smaller person, such as a child who has outgrown child restraints
- or if there is a critical problem with the airbag system or the passenger sensing system.

When the passenger sensing system has turned off the passenger's frontal airbag, the off indicator will light and stay lit to remind you that the airbag is off.

Saab recommends that child restraints be secured in a rear seat, but if a child restraint has been installed and the on indicator is lit, turn the vehicle off. Remove the child restraint from the vehicle and reinstall the child restraint following the child restraint manufacturer's directions and refer to installation of child restraint using the standard safety belt.

If after reinstalling the child restraint and restarting the vehicle, the on indicator is still lit, check to make sure that the vehicle's seatback is not pressing the child restraint into the seat cushion. If this happens, slightly recline the vehicle's seatback and adjust the seat cushion if possible. Also make sure the child restraint is not trapped under the vehicle head restraint. If this happens, adjust the head restraint.

If the on indicator is still lit, secure the child in the child restraint in a rear seat position in the vehicle and check with your dealer.

The passenger sensing system is designed to enable (may inflate) the right front passenger's frontal airbag anytime the system senses that a person of adult size is sitting properly in the right front passenger's seat.

When the passenger sensing system has allowed the airbag to be enabled, the on indicator will light and stay lit to remind you that the airbag is active.

For some children who have outgrown child restraints and for very small adults, the passenger sensing system may or may not turn off the right front passenger's frontal airbag, depending upon the person's seating posture and body build. Everyone in your vehicle who has outgrown child restraints should wear a safety belt properly - whether or not there is an airbag for that person.

If a person of adult size is sitting in the right front passenger's seat, but the off indicator is lit, it could be because

that person is not sitting properly in the seat. If this happens, turn the vehicle off and ask the person to place the seatback in the fully upright position, then sit upright in the seat, centered on the seat cushion, with the person's legs comfortably extended. Restart the vehicle and have the person remain in this position for about two minutes. This will allow the system to detect that person and then enable the passenger's airbag.

⚠Warning

If the airbag indicator light in the instrument panel cluster ever comes on and stays on, it means that something may be wrong with the airbag system. If this ever happens, have the vehicle serviced promptly because an adult-size person sitting in the right front passenger seat may not have the protection of the frontal airbag.

Aftermarket equipment, such as seat covers, can affect how well the passenger sensing system operates. Do

not use seat covers or other aftermarket equipment if your vehicle has the passenger sensing system. See Adding Equipment to Your Airbag-Equipped Vehicle for more information about modifications that can affect how the system operates.

⚠Warning

Stowing of articles under the passenger seat or between the passenger seat cushion and backrest may interfere with the proper operation of the Passenger Sensing System.

Child Restraints

Child Restraint Systems

Older Children

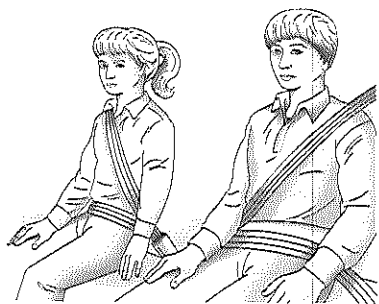

Older children who have outgrown booster seats should wear the vehicle's safety belts.

The manufacturer's instructions that come with the booster seat, state the weight and height limitations for that booster. Use a booster seat with a lap-shoulder belt until the child passes the below fit test:

- Sit all the way back on the seat. Do the knees bend at the seat edge? If yes, continue. If no, return to the booster seat.
- Buckle the lap-shoulder belt. Does the shoulder belt rest on the shoulder? If yes, continue. If no, then return to the booster seat.
- Does the lap belt fit low and snug on the hips, touching the thighs? If yes, continue. If no, return to the booster seat.
- Can proper safety belt fit be maintained for the length of the trip? If yes, continue. If no, return to the booster seat.

② What is the proper way to wear safety belts?

- ① An older child should wear a lap-shoulder belt and get the additional restraint a shoulder belt can provide. The shoulder belt should not cross the face or neck. The lap belt should fit snugly below the hips, just touching the top of the thighs. This applies belt force to the child's pelvic bones in a crash. It should never be worn over the abdomen, which could cause severe or even fatal internal injuries in a crash.

According to accident statistics, children and infants are safer when properly restrained in a child restraint system or infant restraint system secured in a rear seating position. In a crash, children who are not buckled up can strike other people who are buckled up, or can be thrown out of the vehicle. Older children need to use safety belts properly.

⚠ Warning

Never do this. Never allow two children to wear the same safety belt. The safety belt cannot properly spread the impact forces. In a collision, the two children could be crushed together and seriously injured. A safety belt must be used by only one person at a time.

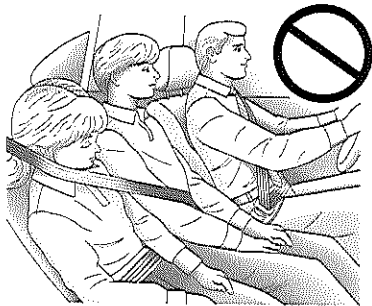
**⚠ Warning**

Never do this.

Never allow a child to wear the safety belt with the shoulder belt behind their back. A child can be seriously injured by not wearing the lap and shoulder belt properly. In a collision, the child would not be restrained by the shoulder belt. The child could be propelled too far forward, increasing the chance of head and neck injury. The child could also slide under the lap belt. The belt force would then be applied right on the abdomen. That could cause serious or fatal injury. The shoulder belt should lie over the shoulder and across the chest.

**Infants and Young Children**

Everyone in a vehicle needs protection! This includes infants and all other children. Neither the distance traveled nor the age and size of the traveler changes the need, for everyone, to use safety restraints. In fact, the law in every state in the United States says children up to some age must be restrained while in a vehicle.

⚠ Warning

Children could be seriously injured or strangled if a shoulder belt is wrapped around their neck and the safety belt continues to tighten. Never leave children unattended in a vehicle and never allow children to play with the safety belts.

Airbags plus lap-shoulder belts offer protection for adults and older children, but not for young children and infants. Neither the vehicle's safety belt system nor its airbag system is designed for them. Every time infants and young children ride in vehicles, they should have the protection provided by appropriate child restraints.

Children who are not restrained properly can strike other people, or can be thrown out of the vehicle.

⚠ Warning

Never do this.

Never hold an infant or a child while riding in a vehicle. In the event of a collision, forces will make an infant or child so heavy that it will not be possible to hold onto him or her. For example, in a collision at only 25 mph, a 12-pound infant will suddenly become a 240-pound force on a person's arms. An infant should be secured in an appropriate restraint.

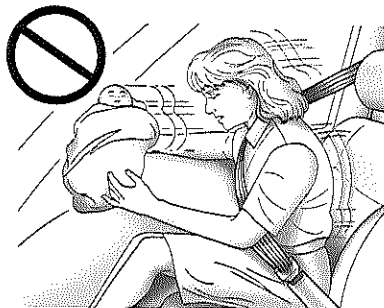
**⚠ Warning**

Never do this.

Children who are up against, or very close to, any airbag when it inflates could be seriously injured or killed. Never put a rear-facing child restraint in the right front seat. Secure a rear-facing child restraint in a rear seat. It is also better to secure a forward-facing child restraint in a rear seat. If you must secure a forward-facing child restraint in the right front seat, always slide the front passenger seat as far back as it will go.

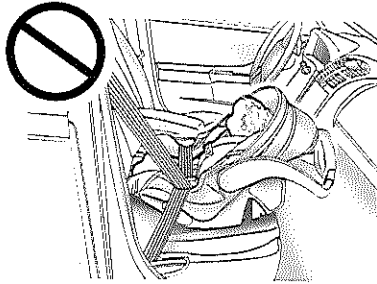

② What are the different types of add-on child restraints?

- ① Add-on child restraints, which are purchased by the vehicle's owner, are available in four basic types. Selection of a particular restraint should take into consideration not only the child's weight, height, and age but also whether or not the restraint will be compatible with the motor vehicle in which it will be used. For most basic types of child restraints, there are many different models available. When purchasing a child restraint, be sure it is designed to be used in a motor vehicle. If it is, the restraint will have a label saying that it meets federal motor vehicle safety standards. The restraint manufacturer's instructions that come with the restraint state the weight and height limitations for a particular child restraint. In addition, there are many kinds of restraints available for children with special needs.

⚠ Warning

To reduce the risk of neck and head injury during a collision, infants need complete support. This is because an infant's neck is not fully developed and its head weighs so much compared to the rest of its body. In a collision, an infant in a rear-facing child restraint settles into the restraint, so the collision forces can be distributed across the strongest part of an infant's body – the back and shoulders. Infants should always be secured in rear-facing child restraints.

⚠ Warning

A young child's hip bones are still so small that the vehicle's regular safety belt may not remain low on the hip bones, as it should. Instead, it may settle up around the child's abdomen. In a collision, the belt would apply force on a body area that is unprotected by any bony structure. This alone could cause serious or fatal injuries. To reduce the risk of serious or fatal injuries during a collision, young children should always be secured in appropriate child restraints.

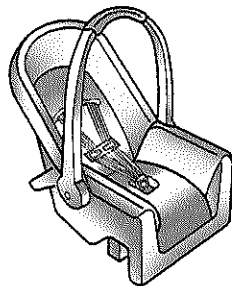
Child Restraint Systems**(A) Rear-Facing Infant Seat**

A rear-facing infant seat (A) provides restraint with the seating surface against the back of the infant.

The harness system holds the infant in place and, in a crash, acts to keep the infant positioned in the restraint.

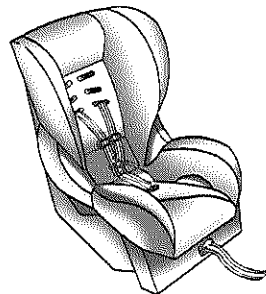
(B) Forward-Facing Child Seat

A forward-facing child seat (B) provides restraint for the child's body with the harness.

(C) Booster Seats

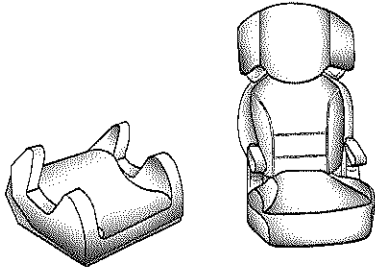

A booster seat (C) is a child restraint designed to improve the fit of the vehicle's safety belt system. A booster seat can also help a child to see out the window.

Securing an Add-On Child Restraint in the Vehicle

⚠ Warning

A child could be seriously injured or killed in a collision if the child restraint is not properly secured in the vehicle. Secure the child restraint properly in the vehicle using the vehicle's safety belt or LATCH system, following the instructions that came with that child restraint and the instructions in this manual.

To help reduce the chance of injury, the child restraint must be secured in the vehicle. Child restraint systems must be secured in vehicle seats by lap belts or the lap belt portion of a lap-shoulder belt, or by the LATCH system. See Lower Anchors and Tethers for Children (LATCH System) ◊ 67.

Children can be endangered in a crash if the child restraint is not properly secured in the vehicle.

When securing an add-on child restraint, refer to the instructions that come with the restraint which may be on the restraint itself or in a booklet, or both, and to this manual. The child restraint instructions are important, so if they are not available, obtain a replacement copy from the manufacturer.

Keep in mind that an unsecured child restraint can move around in a collision or sudden stop and injure people in the vehicle. Be sure to properly secure any child restraint in the vehicle - even when no child is in it.

In some areas, Certified Child Passenger Safety Technicians (CPSTs) are available to inspect and demonstrate how to correctly use and install child restraints. In the U.S., refer to the National Highway Traffic Safety Administration (NHTSA) website to locate the nearest child safety seat inspection station.

Securing the Child Within the Child Restraint

Warning

A child could be seriously injured or killed in a collision if not properly secured in a child restraint. Secure the child properly following the instructions that came with that child restraint.

Where to Put the Restraint

According to accident statistics, children and infants are safer when properly restrained in a child restraint system or infant restraint system secured in a rear seating position.

We recommend that children and child restraints be secured in a rear seat, including: an infant or a child riding in a rear-facing child restraint; a child riding in a forward-facing child seat; an older child riding in a booster seat; and children, who are large enough, using safety belts.

Never put a rear-facing child seat in the front. This is because the risk to the rear-facing child is so great if the airbag deploys.

Warning

A child in a rear-facing child restraint can be seriously injured or killed if the right front passenger airbag is deployed. This is because the back of the rear-facing child restraint would be very close to the inflating airbag. A child in a forward-facing child restraint can be seriously injured or killed if the right front passenger airbag is deployed and the passenger seat is slid forward.

Even if the Passenger Sensing System has deactivated the right front passenger frontal airbag, no system is fail-safe. No one can guarantee that an airbag will not deploy under some unusual circumstance, even though it is deactivated.

Secure rear-facing child restraints in a rear seat, even if the airbag is deactivated. If you must secure a forward-facing child restraint in the right front seat, always slide

the front passenger seat as far back as it will go. It is better to secure the child restraint in a rear seat.

Passenger Sensing System, additional information ⇨ 57.

When securing a child restraint in a rear seating position, study the instructions that came with your child restraint to make sure it is compatible with this vehicle.

Child restraints and booster seats vary considerably in size, and some may fit in certain seating positions better than others. Always make sure the child restraint is properly secured.

Depending on where you place the child restraint and the size of the child restraint, you may not be able to access adjacent safety belt assemblies or LATCH anchors for additional passengers or child restraints. Adjacent seating positions should not be used if the child restraint prevents access to or interferes with the routing of the safety belt.

Wherever a child restraint is installed, be sure to secure the child restraint properly.

Keep in mind that an unsecured child restraint can move around in a collision or sudden stop and injure people in the vehicle. Be sure to properly secure any child restraint in your vehicle - even when no child is in it.

Child Restraint Installation Locations

Lower Anchors and Tethers for Children (LATCH System)

The LATCH system holds a child restraint during driving or in a crash. This system is designed to make installation of a child restraint easier. The LATCH system uses anchors in the vehicle and attachments on the child restraint that are made for use with the LATCH system.

Make sure that a LATCH-compatible child restraint is properly installed using the anchors, or use the vehicle's safety belts to secure the restraint,

following the instructions that came with that restraint, and also the instructions in this manual.

When installing a child restraint with a top tether, you must also use either the lower anchors or the safety belts to properly secure the child restraint. A child restraint must never be installed using only the top tether and anchor.

In order to use the LATCH system in the vehicle, you need a child restraint that has LATCH attachments. The child restraint manufacturer will provide you with instructions on how to use the child restraint and its attachments. The following explains how to attach a child restraint with these attachments in the vehicle.

Not all vehicle seating positions or child restraints have lower anchors and attachments or top tether anchors and attachments.

Lower Anchors

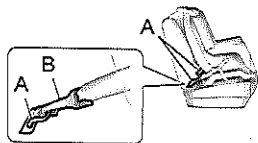

Lower anchors (A) are metal bars built into the vehicle. There are two lower anchors for each LATCH seating position that will accommodate a child restraint with lower attachments (B).

Top Tether Anchor

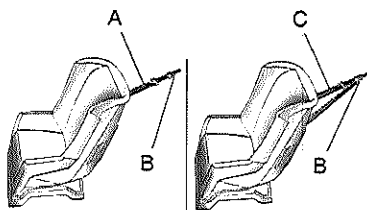

A top tether (A, C) anchors the top of the child restraint to the vehicle. A top tether anchor is built into the vehicle. The top tether attachment (B) on the child restraint connects to the top tether anchor in the vehicle in order to reduce the forward movement and rotation of the child restraint during driving or in a crash.

The child restraint may have a single tether (A) or a dual tether (C). Either will have a single attachment (B) to secure the top tether to the anchor.

Some child restraints that have a top tether are designed for use with or without the top tether being attached. Others require the top tether always to be attached. Be sure to read and follow the instructions for the child restraint.

Lower Anchor and Top Tether Anchor Locations

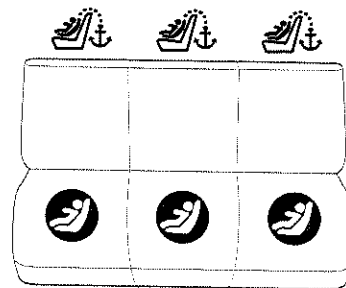

Rear Seat

Lower Anchor: Seating positions with two lower anchors.



To assist you in locating the lower anchors, each rear anchor position has a label, near the crease between the seatback and the seat cushion.

Top Tether Anchor: Seating positions with top tether anchors.



To assist you in locating the top tether anchors, the top tether anchor symbol is located on the cover.

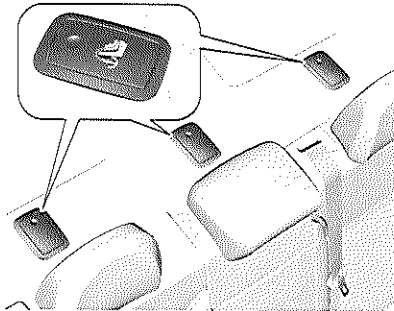

The top tether anchors are located under the covers, behind the rear seat, on the filler panel. Be sure to use an anchor located on the same side of the vehicle as the seating position where the child restraint will be placed.

Do not secure a child restraint in a position without a top tether anchor if a national or local law requires that the top tether be attached, or if the instructions that come with the child restraint say that the top tether must be attached.

According to accident statistics, children and infants are safer when properly restrained in a child restraint system or infant restraint system secured in a rear seating position.

See "Where to Put the Restraint" in the previous section for additional information.

Securing a Child Restraint Designed for the LATCH System

⚠ Warning

If a LATCH-type child restraint is not attached to anchors, the child restraint will not be able to protect the child correctly. In a collision, the child could be seriously injured or killed. Install a LATCH-type child restraint properly using the anchors, or use the vehicle's safety belts to secure the restraint, following the instructions that came with the child restraint and the instructions in this manual.

⚠ Warning

Do not attach more than one child restraint to a single anchor. Attaching more than one child restraint to a single anchor could cause the anchor or attachment to come loose or even break during a collision. A child or others could be injured. To reduce the risk of serious or fatal injuries during a collision, attach only one child restraint per anchor.

Notice

Do not let the LATCH attachments rub against the vehicle's safety belts. This may damage these parts. If necessary, move buckled safety belts to prevent them from rubbing against the LATCH attachments. Do not fold the empty rear seat with a safety belt buckled. This could damage the safety belt or the seat. Unbuckle and return the safety belt to its stowed position before folding the seat.

If you need to secure more than one child restraint in the rear seat, see "Where to Put the Restraint" in the previous section.

You cannot secure three child restraints using the LATCH anchors in the rear seat at the same time, but you can install two of them. If you want to do this, install one LATCH child restraint in the passenger-side position, and install the other one either in the driver-side position or in the center position. If you need to install child restraints in both the center and driver-side position, the one in the center seating position will need to be secured using the vehicle safety belts instead of the LATCH anchors.

Refer to the following illustration to learn which anchors to use.

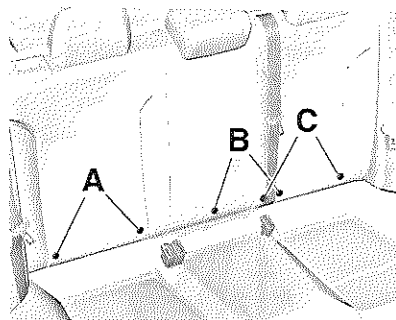

- A = Passenger Side Rear Seating Position and Lower Anchors 1 and 2
- B = Center Rear Seating Position and Lower Anchors 3 and 5
- C = Driver Side Rear Seating Position and Lower Anchors 4 and 6

There are six lower LATCH anchors in the rear seat.

- Use anchors 1 and 2 when installing a child restraint using LATCH in seating position A.
- Use anchors 3 and 5 when installing a child restraint using LATCH in seating position B.
- Use anchors 4 and 6 when installing a child restraint using LATCH in seating position C.

Installing child restraints using LATCH in seating positions B and C at the same time is prohibited.

Make sure to attach the child restraint at the proper anchor location.

This system is designed to make installation of child restraints easier. When using lower anchors, do not use the vehicle's safety belts. Instead use the vehicle's anchors and child restraint attachments to secure the restraints. Some restraints also use another vehicle anchor to secure a top tether.

1. Attach and tighten the lower attachments to the lower anchors. If the child restraint does not have lower attachments or the desired

seating position does not have lower anchors, secure the child restraint with the top tether and the safety belts. Refer to the child restraint manufacturer instructions and the instructions in this manual.

- 1.1. Find the lower anchors for the desired seating position.

- 1.2. Put the child restraint on the seat. If the head restraint interferes with the proper installation of the child restraint, the head restraint may be removed. See "Head Restraint Removal and Reinstallation" at the end of this section.

- 1.3. Attach and tighten the lower attachments on the child restraint to the lower anchors.

2. If the child restraint manufacturer recommends that the top tether be attached, attach and tighten the top tether to the top tether anchor, if equipped. Refer to the child restraint instructions and the following steps:

- 2.1. Find the top tether anchor. Open the cover to expose the anchor.

- 2.2. Route, attach, and tighten the top tether according to the child restraint instructions and the following instructions:

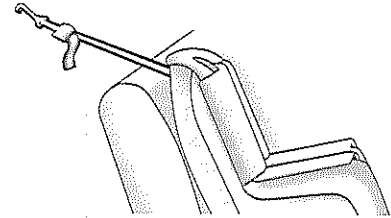

If the position you are using does not have a headrest or head restraint, or the headrest or head restraint has been removed, and you are using a single tether, route the tether over the seatback.

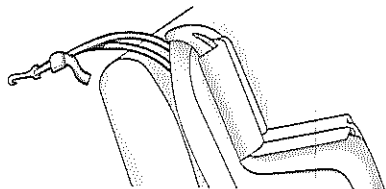

If the position you are using does not have a headrest or head restraint, or the headrest or head restraint has been removed, and you are using a dual tether, route the tether over the seatback.

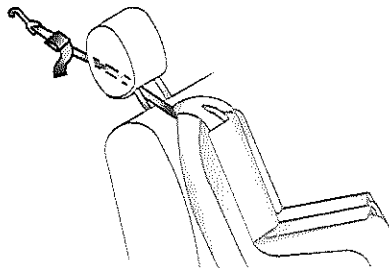

If the position you are using has an adjustable headrest or head restraint and you are using a single tether, route the tether under the headrest or head restraint and in between the headrest or head restraint posts. Head Restraints ◊ 33.

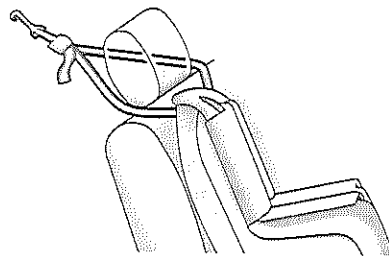

If the position you are using has an adjustable headrest or head restraint and you are using a dual tether route the tether around the headrest or head restraint.

3. Before placing a child in the child restraint, make sure it is securely held in place. To check, grasp the child restraint at the LATCH path and attempt to move it side-to-side and back-and-forth. There should be no more than one inch of movement, for proper installation.

Head Restraint Removal and Reinstallation

The rear outboard head restraints can be removed if they interfere with the proper installation of the child restraint.

To remove the head restraint:

1. Partially fold the seatback forward. Rear Seats ⇨ 82 for additional information.

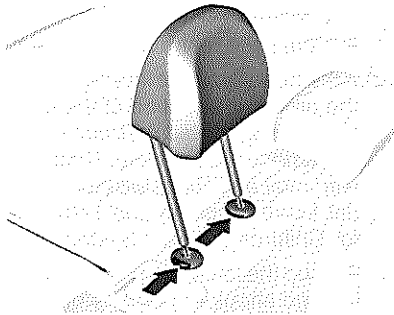

2. To remove rear head restraint press the catch on the right sleeve and press the release on the left sleeve with a steeple object. Pull the headrest upwards.

3. Store the head restraint in the trunk of the vehicle.
4. When the child restraint is removed, reinstall the head restraint before the seating position is used.

⚠ Warning

There is a greater chance that occupants will suffer a neck/spinal injury in a collision if the head restraints are not properly installed and adjusted. Do not drive until the head restraints for all occupants are installed and adjusted properly.

To reinstall the head restraint:

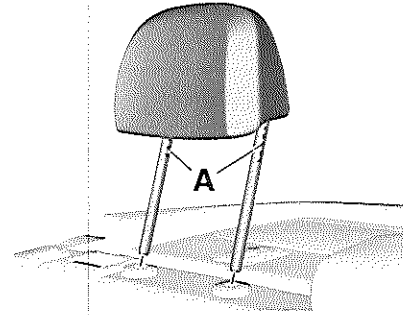

1. Insert the head restraint posts into the holes in the top of the seatback. The notches (A) on the posts must face the driver side of the vehicle.
2. Push the head restraint all the way down.
3. Pull up on the head restraint to be sure that it locks.

Replacing LATCH System Parts After a Crash

⚠ Warning

A collision could damage the LATCH system in the vehicle. A damaged LATCH system may fail to properly secure the child restraint, resulting in serious injury or even death in a collision. To help make sure the LATCH system is working properly after a collision, see your dealer to have the system inspected and any necessary replacements made as soon as possible.

If the vehicle has the LATCH system and it was being used during a crash, new LATCH system parts may be needed.

New parts and repairs may be necessary even if the LATCH system was not being used at the time of the crash.

Securing Child Restraints (Rear Seat)

When securing a child restraint in a rear seating position, study the instructions that came with the child restraint to make sure it is compatible with this vehicle.

If the child restraint has the LATCH system, see "Lower Anchors and Tethers for Children (LATCH System)" in the previous section to find out how and where to install the child restraint using LATCH. If a child restraint is secured in the vehicle using a safety belt and it uses a top tether, see "Lower Anchors and Tethers for Children (LATCH System)" in the previous section for top tether anchor locations.

Do not secure a child seat in a position without a top tether anchor if a national or local law requires that the top tether be anchored, or if the instructions that come with the child restraint say that the top strap must be anchored.

If the child restraint does not have the LATCH system, you will be using the safety belt to secure the child restraint in this position. Be sure to follow the instructions that came with the child restraint. Secure the child in the child restraint when and as the instructions say.

If more than one child restraint needs to be installed in the rear seat, be sure to read "Where to Put the Restraint" in the previous section.

1. Put the child restraint on the seat.

If the head restraint interferes with the proper installation of the child restraint, the head restraint may be removed. See "Head Restraint Removal and Reinstallation" under Lower Anchors and Tethers for Children (LATCH System).

2. Pick up the latch plate, and run the lap and shoulder portions of the vehicle's safety belt through or around the restraint. The child restraint instructions will show you how.

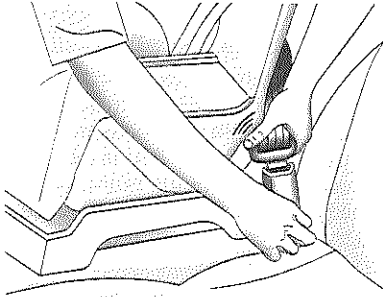

3. Push the latch plate into the buckle until it clicks. Position the release button on the buckle so that the safety belt could be quickly unbuckled if necessary.

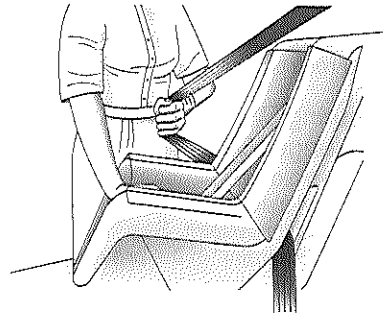

4. Pull the shoulder belt all the way out of the retractor to set the lock. When the retractor lock is set, the belt can be tightened but not pulled out of the retractor.

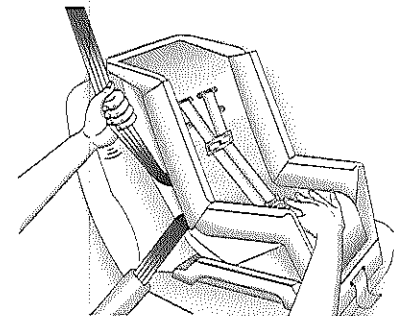

5. To tighten the belt, push down on the child restraint, pull the shoulder portion of the belt to tighten the lap portion of the belt, and feed the shoulder belt back into the retractor. When installing a forward-facing child restraint, it may be helpful to use your knee to push down on the child restraint as you tighten the belt.

Try to pull the belt out of the retractor to make sure the retractor is locked. If the retractor is not locked, repeat Steps 4 and 5.

6. If the child restraint has a top tether, follow the child restraint manufacturer's instructions regarding the use of the top tether. See "Lower Anchors and Tethers for Children (LATCH System)" in the previous section for more information.
7. Before placing a child in the child restraint, make sure it is securely held in place. To check, grasp the child restraint at the safety belt path and attempt to move it side-to-side and back-and-forth. When the child restraint is properly installed, there should be no more than one inch of movement.

To remove the child restraint, unbuckle the vehicle safety belt and let it return to the stowed position. If the top tether is attached to a top tether anchor, disconnect it. If the head restraint was removed, reinstall it before the seating position is used. See "Head Restraint Removal and Reinstallation" under "Lower Anchors and Tethers for Children (LATCH Sys-

tem)" in the previous section for additional information on installing the head restraint properly.

Securing Child Restraints (Front Passenger Seat)

This vehicle has airbags. A rear seat is a safer place to secure a forward-facing child restraint. See "Where to Put the Restraint" in the previous section.

In addition, the vehicle has a passenger sensing system which is designed to turn off the right front passenger frontal airbag and seat-mounted side impact airbag under certain conditions. See Passenger Sensing System ↻ 57 and Seat occupancy recognition ↻ 99 for more information, including important safety information.

Never put a rear-facing child seat in the front. This is because the risk to the rear-facing child is so great if the airbag deploys.

⚠ Warning

A child in a rear-facing child restraint can be seriously injured or killed if the right front passenger airbag is deployed. This is because the back of the rear-facing child restraint would be very close to the inflating airbag. A child in a forward-facing child restraint can be seriously injured or killed if the right front passenger airbag is deployed and the passenger seat is slid forward.

Even if the Passenger Sensing System has deactivated the right front passenger frontal airbag, no system is fail-safe. No one can guarantee that an airbag will not deploy under some unusual circumstance, even though it is deactivated.

Secure rear-facing child restraints in a rear seat, even if the airbag is deactivated. If you must secure a forward-facing child restraint in the right front seat, always slide

the front passenger seat as far back as it will go. It is better to secure the child restraint in a rear seat.

See Passenger Sensing System
◇ 57 for additional information.

If the child restraint has the LATCH system, see Lower Anchors and Tethers for Children (LATCH System) in the previous section for how and where to install the child restraint using LATCH. If a child restraint is secured using a safety belt and it uses a top tether, see "Lower Anchors and Tethers for Children (LATCH System)" for top tether anchor locations in the previous section.

Do not secure a child seat in a position without a top tether anchor if a national or local law requires that the top tether be anchored, or if the instructions that come with the child restraint say that the top strap must be anchored.

You will be using the lap-shoulder belt to secure the child restraint in this position. Follow the instructions that came with the child restraint.

1. Move the seat as far back as it will go before securing the forward-facing child restraint.

When the passenger sensing system has turned off the right front passenger frontal airbag and seat-mounted side airbag, the off indicator on the passenger airbag status indicator should light and stay lit when you start the vehicle. Seat occupancy recognition
◇ 99.

2. Put the child restraint on the seat.
3. Pick up the latch plate, and run the lap and shoulder portions of the vehicle's safety belt through or around the restraint. The child restraint instructions will show you how.

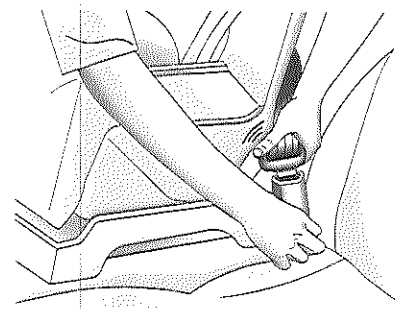

4. Push the latch plate into the buckle until it clicks.
Position the release button on the buckle so that the safety belt could be quickly unbuckled if necessary.

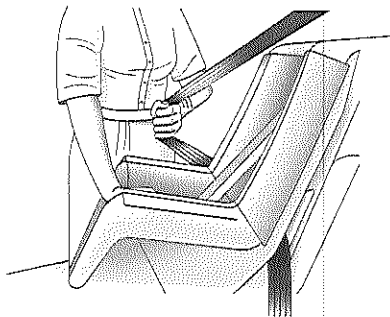

5. Pull the shoulder belt all the way out of the retractor to set the lock. When the retractor lock is set, the belt can be tightened but not pulled out of the retractor.

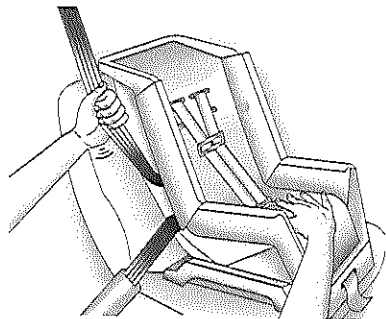

6. To tighten the belt, push down on the child restraint, pull the shoulder portion of the belt to tighten the lap portion of the belt, and feed the shoulder belt back into the retractor. When installing a forward-facing child restraint, it may be helpful to use your knee to push down on the child restraint as you tighten the belt.

Try to pull the belt out of the retractor to make sure the retractor is locked. If the retractor is not locked, repeat Steps 5 and 6.

7. Before placing a child in the child restraint, make sure it is securely

held in place. To check, grasp the child restraint at the safety belt path and attempt to move it side-to-side and back-and-forth. When the child restraint is properly installed, there should be no more than one inch of movement.

If the airbags are off, the off indicator in the passenger airbag status indicator will come on and stay on when the vehicle is started.

If a child restraint has been installed and the on indicator is lit.

To remove the child restraint, unbuckle the vehicle safety belt and let it return to the stowed position.

Storage

Storage Compartments 79
Additional Storage Features 82
Roof Rack System 86
Information on Loading the Vehicle 86

Storage Compartments

Glove Box

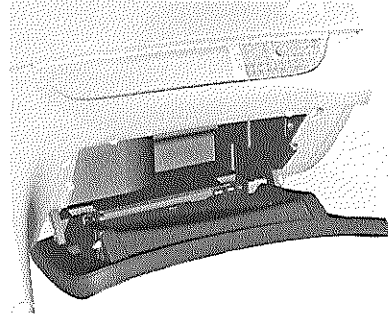

Pull the grip to open the glove box lid. The glove box should be closed while driving.

Cupholders

Cupholders are located in the front center console.

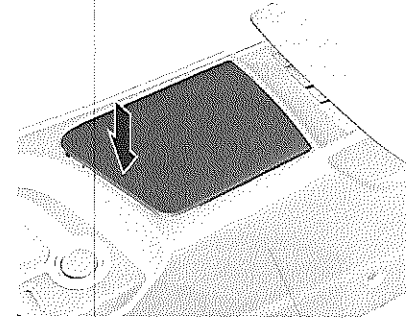

To open the console push on the front end of the cover.

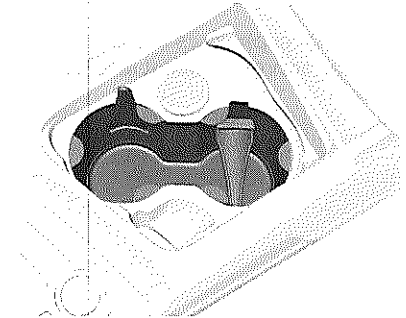

Fold in the bracket for the height adjustment before fitting a small cup in the cupholder.

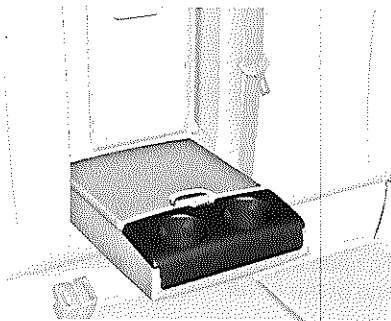

Additional cupholders are located in the rear armrest, when it is folded down.

Front Storage

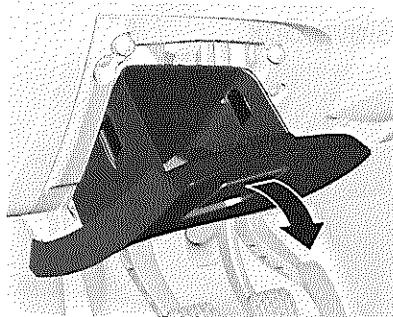

A storage compartment is located next to the steering wheel.

To open pull the grip.

Armrest Storage

Storages in the front armrest

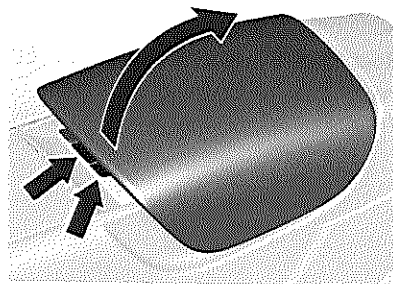

On some versions the front armrest contains two storages.

Pull left button to open a small storage.

Pull middle button to fold up the armrest containing a large storage.

Inside the large storage there is a CD slot.

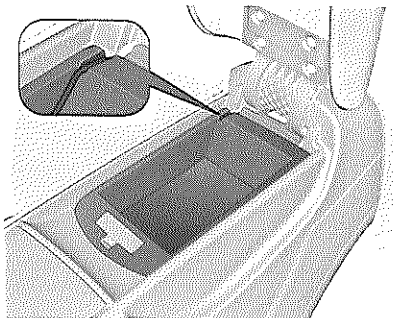

The small storage contains a cable duct right from the hinge. If depositing a mobile phone or media player in the storage, put the cable inside the duct. Another cable duct is in the front part of the armrest.

Storage in the rear armrest

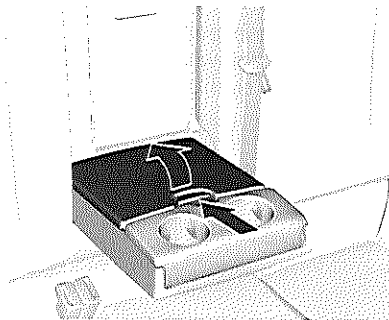

Fold down armrest and open cover. Close cover before folding the armrest up.

Center Console Storage

Rear console

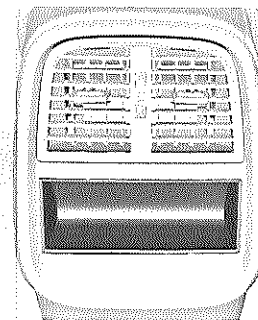

There is a storage compartment in the rear center console in front of the rear seats.

Additional Storage Features

Load Compartment

Folding down rear seat backrests

The rear seat backrest is divided into two parts. Both parts can be folded down.

Press and hold the catch, then push the head restraints down.

Fold up the rear armrest.

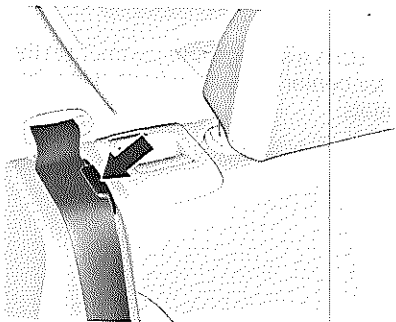

Put the safety belts of the outboard seats into the belt guides.

Pull the release lever on one or both sides and fold down the backrests onto the seat cushion.

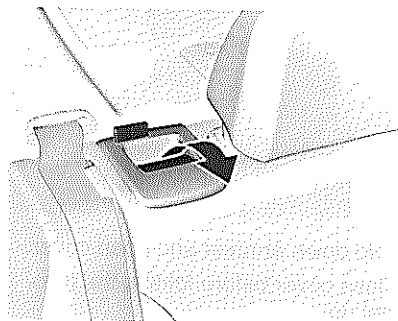

To fold up, raise backrests and guide them into an upright position until they engage audibly.

Ensure that the safety belts of the outboard seats are placed in the corresponding belt guides.

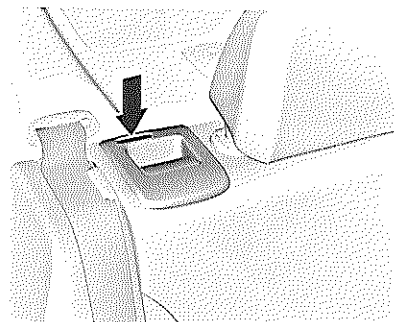

The backrests are properly engaged when both red marks on the side near the release lever are no longer visible.

Warning

Never drive the car if the backrests are not securely locked into position, as this increases the risk of personal injury or damage to the load or car in the event of heavy braking or a collision.

Opening the pass-through in the rear center backrest

Fold down rear armrest.

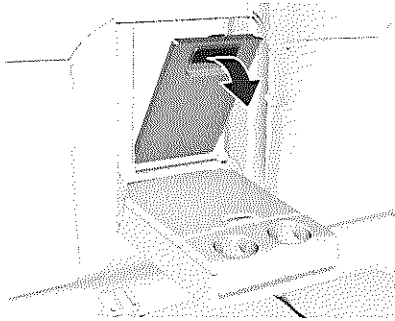

Pull grip and open the cover.

Suitable for loading long, narrow objects.

Ensure the cover engages after folding up.

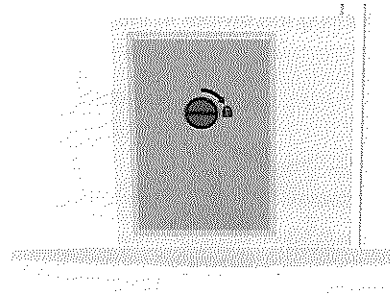

The closed cover can be secured from the side of the trunk. Turn knob by 90°:

- | | |
|-----------------|--|
| Knob horizontal | = cover secured from the side of the passenger compartment |
| Knob vertical | = cover not secured |

Lashing Eyes

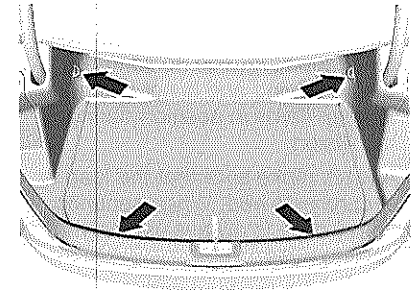

The lashing eyes are designed to secure items against slippage, e.g. using lashing straps or luggage net.

Cargo Management System

Trunk divider

The vehicle can be equipped with a trunk dividing system. It is a movable system that divides the trunk into two flexible parts.

⚠ Warning

The load compartment divider system keeps luggage items in place during driving and is not designed to keep items in position during a collision.

Always make sure that the load is securely stowed. When securing heavy objects always use only the lashing eyes.

Do not use the load compartment divider components in combination with lashing straps attached to lashing eyes to secure heavy objects.

Mounting the divider in the rail

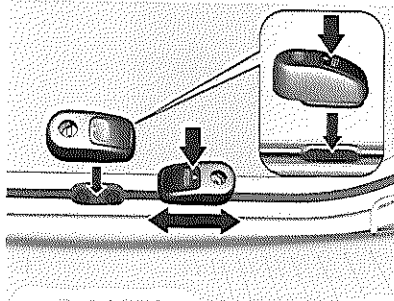

Insert both adapters with the small end mirrorwise into the rail in the trunk bottom. Thereby use the entry in the rail and press the button in the adapter while inserting it.

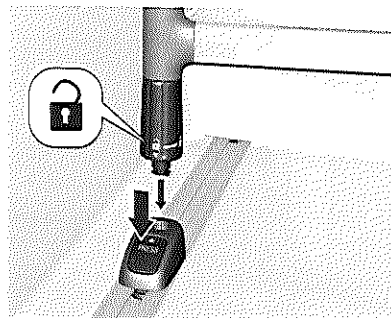

Insert the retainer into the adapter while pressing the button. Note that the arrow on the catch  is in accordance with the arrow on the adapter. Repeat the procedure with the retainer on the other side.

Sliding the divider

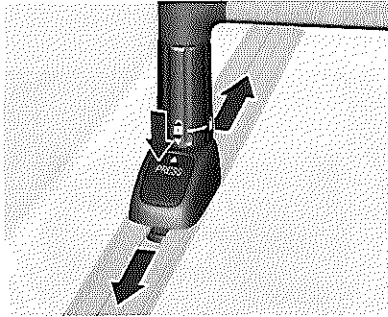

Press the button on each adapter one after another and slide the divider in the rail of the trunk.

The catch must not be locked while sliding the divider in the rail.

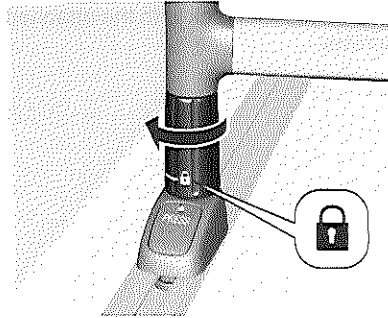

After adjusting the divider, turn the catch of each retainer clockwise as firmly as possible.

Removing

Remove the trunk divider in reverse order.

The button on the adapter must be pressed to release the divider from the adapter.

Umbrella and grocery bag holder

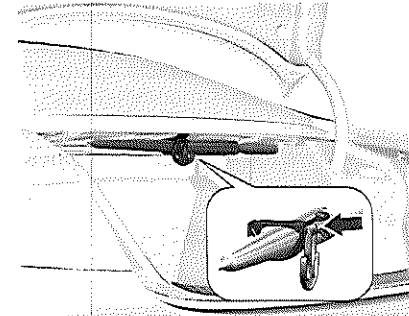

Pull the hook from the holder. Put the umbrella into to the holder, pass the strap belt around it and fit the hook into the holder.

The hook can be hinged down. In this position grocery bags can be hung up.

There are two more grocery bag holders on the left and right side of the trunk.

Roof Rack System

Roof Rack

For safety reasons and to avoid damage to the roof, the vehicle approved roof rack system is recommended.

Follow the installation instructions and remove the roof rack when not in use.

Mounting roof rack

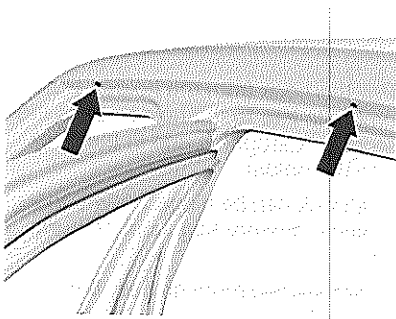

Open all doors.

Mounting points are located in each door frame of the vehicle body.

Fasten the roof rack with the attached screws.

Information on Loading the Vehicle

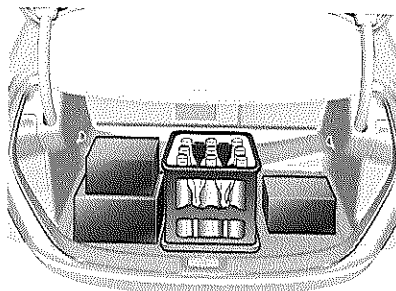

- Heavy objects in the trunk should be placed against the seat backrests. Make sure that the backrests are securely engaged, hence no longer showing the red markings on the side near the release lever. If objects can be stacked, heavier objects should be placed at the bottom.
- Secure objects with lashing straps attached to lashing eyes ⇨ 83.

- Secure loose objects in the trunk to prevent from sliding.
- When transporting objects in the trunk, the backrests of the rear seats must not be angled forward.
- Do not place any objects behind the rear head restraints or the instrument panel, and do not cover the sensor on top of the instrument panel.
- The load must not obstruct the operation of the pedals, parking brake switch and gear selector, or hinder the freedom of movement of the driver. Do not place any unsecured objects in the interior.
- Do not drive with an open trunk.

Warning

Always make sure that the load in the vehicle is securely stowed. Otherwise objects can be thrown around inside the car and cause personal injury or damage to the load or car.

- The payload is the difference between the permitted gross vehicle weight rating (GVWR) (see identification plate ⇨ 226) and the curb weight.

Curb weight means the weight of a motor vehicle with standard and optional equipment including the maximum capacity of fuel, oil and coolant, without passengers and cargo.

Optional equipment and accessories increase the curb weight.

- Driving with a roof load increases the sensitivity of the vehicle to cross-winds and has a detrimental effect on vehicle handling due to the vehicle's higher center of gravity. Distribute the load evenly and secure it properly with retaining straps. Adjust the tire pressure and vehicle speed according to the load conditions. Check and retighten the straps frequently.

The permissible roof load is 220 lbs. The roof load is the combined weight of the roof rack and the load.

Tires, Loading your vehicle ⇨ 190

Instruments and Controls

Controls	88
Warning Lights, Gages, and Indicators	93
Information Displays	103
Vehicle Messages	111
Trip Computer	112
Vehicle Personalization	114
OnStar® System	119
Universal Remote System	120

Controls

Steering Wheel Adjustment

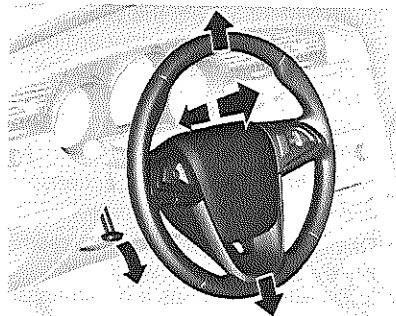

Unlock lever, adjust steering wheel, then engage lever and ensure it is fully locked.

Do not adjust steering wheel unless vehicle is stationary.

Steering Wheel Controls

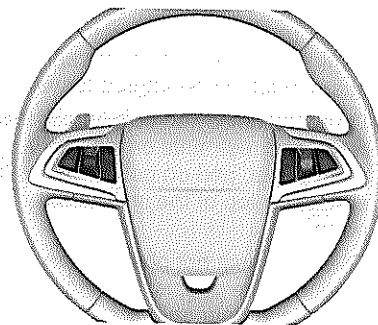

The Cruise control, the Infotainment system, settings for the OnStar® System and the Automatic transmission can be operated via the controls on the steering wheel.

Infotainment system: further information is available in the separate manual.

Cruise control ⇨ 156.

OnStar® ⇨ 119

Automatic transmission steering wheel shifter ⇨ 146.

Horn

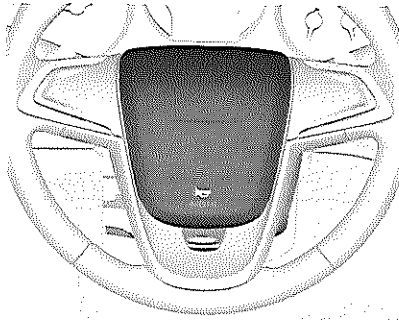



Press .

Windshield Wiper/Washer

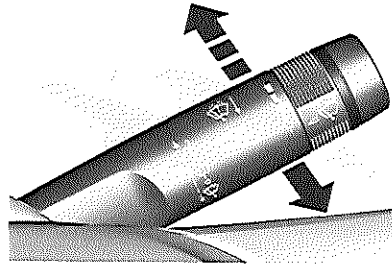
Wiping functions





- 2 = fast continuous
- 1 = slow continuous
-  = automatic wiping with rain sensor
- = off

The rain sensor detects the amount of water on the windshield and automatically regulates the frequency of the windshield wiper. Activated rain sensor is indicated by  in the Driver Information Center (DIC).

For a single wipe when the windshield wiper is off, press the lever down. Do not use if the windshield is frozen. Switch off in car washes.

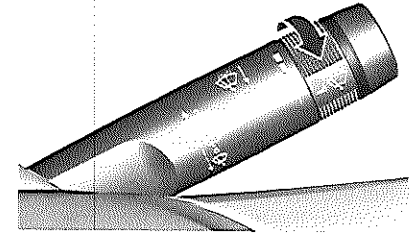
Adjustable sensitivity of the rain sensor



Wiper switch in . Turn the adjuster wheel to adjust the sensitivity:

- Low sensitivity = turn adjuster wheel downwards
- High sensitivity = turn adjuster wheel upwards

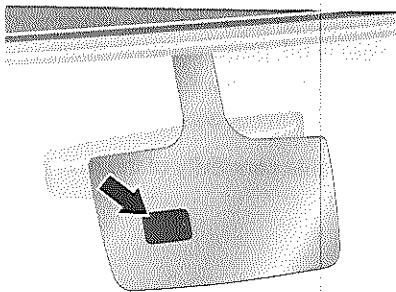

Keep the sensor free from dust, dirt and ice.

Caution

Set the lever in position **O** before clearing the windshield from ice.

Windshield and headlamp washer

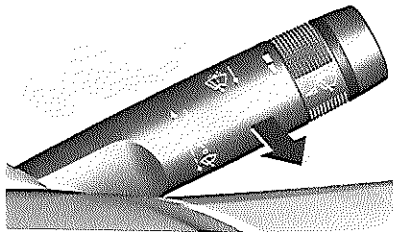

Pull lever. Washer fluid is sprayed onto the windshield and the wiper wipes a few times.

If the headlamps are on, washer fluid is also sprayed onto the headlamps.

Outside temperature

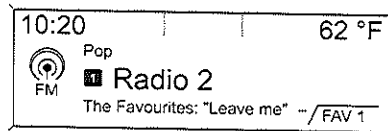

Temperature is displayed in the Info Display.

A drop in temperature is indicated immediately and a rise in temperature after a time delay.

If outside temperature is between 26 - 38 °F, a warning message  **Possible Drive with Care** appears in the Driver Information Center (DIC) as a warning for possible icy road conditions. The message can be cleared by pressing the **SET/CLR** button, or it disappears self-kindled after 10 seconds.

⚠ Warning

The road surface may already be icy even though the display indicates a few degrees above 32°F

Compass

Compass information is displayed on the Driver Information Center (DIC) by a heading arrow and the global orientation (North, East, South, West).

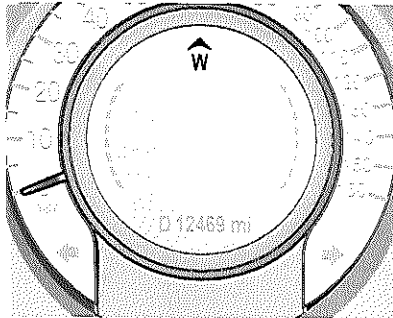

The compass receives its heading and other information from Global Positioning System (GPS) antenna, Electronic Stability Control system

and vehicle speed information. Avoid covering the GPS antenna for long periods of time with objects that may interfere with the antenna's ability to receive a satellite signal.

Compass messages

The compass system is designed to operate for a certain number of miles or degrees of turn before needing a signal from the GPS satellites.

When the compass display shows **CAL**, the compass needs to be calibrated. Drive the vehicle for a short distance in an open area where it can receive a GPS signal.

The compass system will automatically determine when GPS signal is restored and provide a heading again.

--- is indicated when the compass needs service. Seek the assistance of a workshop.

Clock

Date and time are shown in the Information Display.

Graphic Information Display

Set Date and Time

Press the **CONFIG** button. The **Settings** menu is displayed.

Select **Time & Date**.

Selectable setting options:

- **Set time:** Changes the time shown on the display.
- **Set date:** Changes the date shown on the display.
- **Set time format:** Changes clock mode from **12 hours** to **24 hours**.
- **Set date format:** Changes date mode from **MM/DD/YYYY** to **DD.MM.YYYY**.
- **RDS clock synchronization:** The RDS signal of most VHF transmitters automatically sets the time. RDS time synchronization can take a few minutes. Some transmitters do not send a correct time signal. In such cases, it is recommended to switch off automatic time synchronization.

Color Information Display with Touchscreen Functionality

Set Date and Time

Press the **CONFIG** button.

To enter the **Time** menu, press the **CONFIG** button repeatedly, or press one of the screen buttons at the top of the screen. Follow the menu instructions.

Vehicle personalization ⇨ 114.

Power Outlets

12 Volts power outlets are located in the front center console, in the storage of the armrest and in the trunk on the left side.

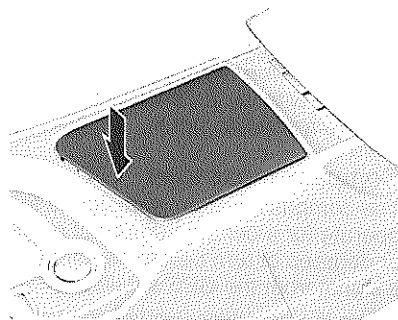

To open the front center console push on the front end of the cover.

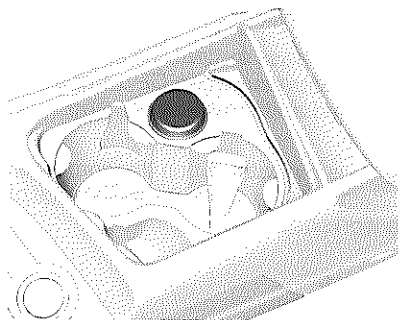

Pull middle button to fold up the armrest.

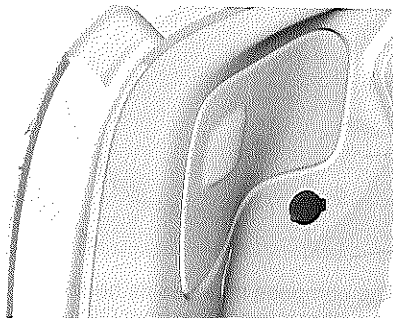
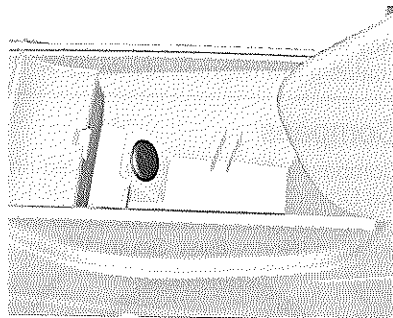

Do not exceed the maximum power consumption of 120 Watts.

With ignition off the power outlets are deactivated. Additionally the power outlets are deactivated in the event of low battery voltage.

Electrical accessories that are connected must comply with the electromagnetic compatibility requirements.

Do not connect any current-delivering accessories, e.g. electrical charging devices or batteries.

Do not damage the outlets by using unsuitable plugs.

Warning Lights, Gages, and Indicators

Speedometer

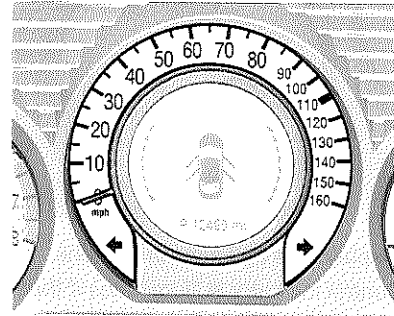

Indicates vehicle speed.

Odometer

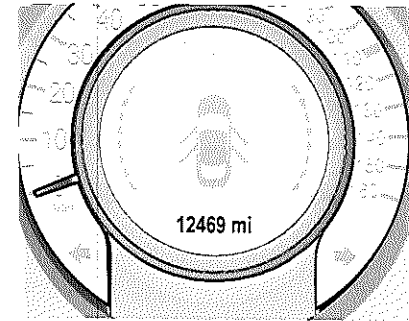

The bottom line displays the total mileage driven.

Tachometer

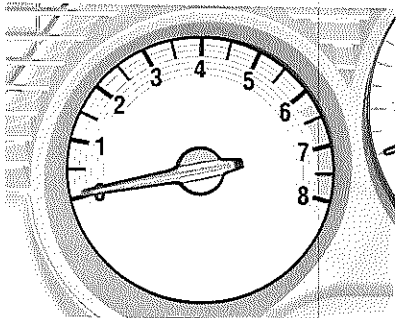



Displays the engine speed. Drive in the lower end of each gear's engine speed range as much as possible.

Caution

If the needle is in the red warning zone, the maximum permitted engine speed is exceeded. Engine at risk.

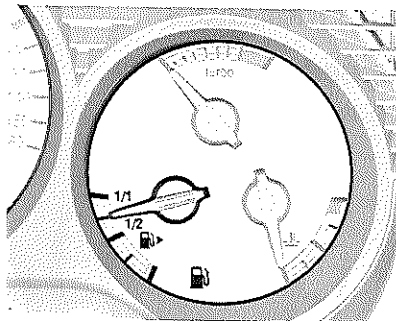

Fuel Gauge



Displays the fuel level in the tank. Control indicator  illuminates if the level in the tank is low. Refuel immediately.

Never run the tank dry.

Because of the fuel remaining in the tank, the top-up quantity may be less than the specified tank capacity.

The  arrow near the  symbols indicates that the gas cap door is on the right side of the vehicle.

Boost Gage

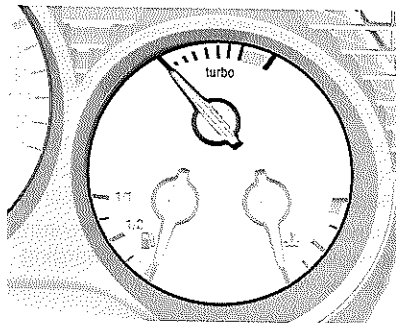

The turbo gauge indicates the air volume for combustion, which is equivalent to the engine load.

Under certain barometric conditions, the needle may enter the first part of the red zone.

If the needle repeatedly enters the red zone and the engine loses power at the same time, seek the assistance of a workshop.

Engine Coolant Temperature Gage

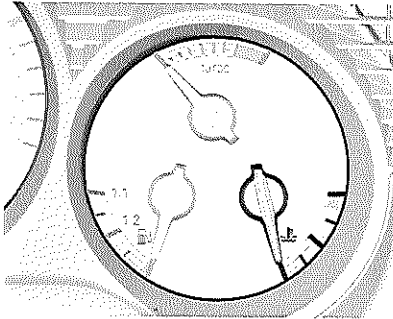

Displays the coolant temperature.

- Red zone = Temperature too high
- Central zone = Normal operating temperature
- Bottom zone = Engine operating temperature not yet reached

Caution

If engine coolant temperature is too high, stop the vehicle and allow the engine to idle. If the needle continues to rise into the red zone, switch off the engine. Check the coolant level.

⚠ Warning

Never open the expansion tank cap completely when the engine is hot; open with care. The pressure in the cooling system could cause hot coolant and steam to be released. Failure to heed this warning could result in personal injury.

Service Display

The engine oil life system lets you know when it is time for service. Based on driving conditions, the interval at which an engine oil and filter change will be indicated can vary considerably.

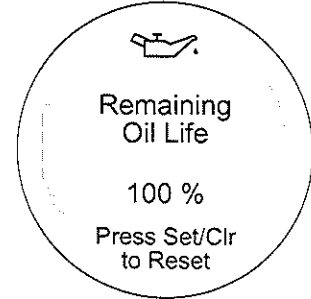

The remaining oil life duration is displayed in the **Vehicle Information Menu** in the Driver Information Menu. The menu and function can be selected via the buttons on the turn signal lever.

To display the remaining engine oil duration:

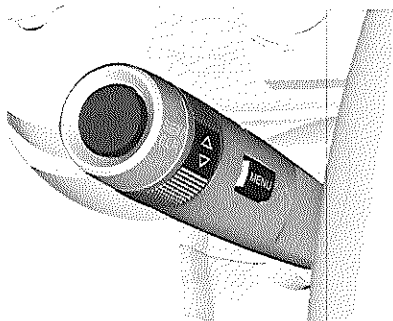

Press the **MENU** button to select the **Vehicle Information Menu**.

Turn the adjuster wheel to select **Remaining Oil Life**.

For the system to work properly, it must be reset every time the engine oil is changed. Seek the assistance of a workshop.

Press the **SET/CLR** button to reset engine oil life system. Thereby the ignition has to be in **Ignition on** mode (green LED in **Start/Stop** button is on) but engine not running.

When the system has calculated that engine oil life has been diminished, **Change Engine Oil Soon** appears in the Driver Information Center (DIC).

Driver Information Center (DIC)
 ⇨ 103.

Service information ⇨ 223.

Control Indicators

The control indicators described are not present in all vehicles. The description includes all equipment levels. When the ignition mode is switched on by pressing **Start/Stop** button once, most control indicators will illuminate briefly as a functionality test.

The control indicator colors mean:

- Red = Danger, Important reminder
- Yellow = Warning, Information, Fault
- Green = Confirmation of activation
- Blue = Confirmation of activation

On some of the following control indicators an additional message appears in the Driver Information Center (DIC), when they are illuminating or flashing.

Control indicators in the instrument cluster

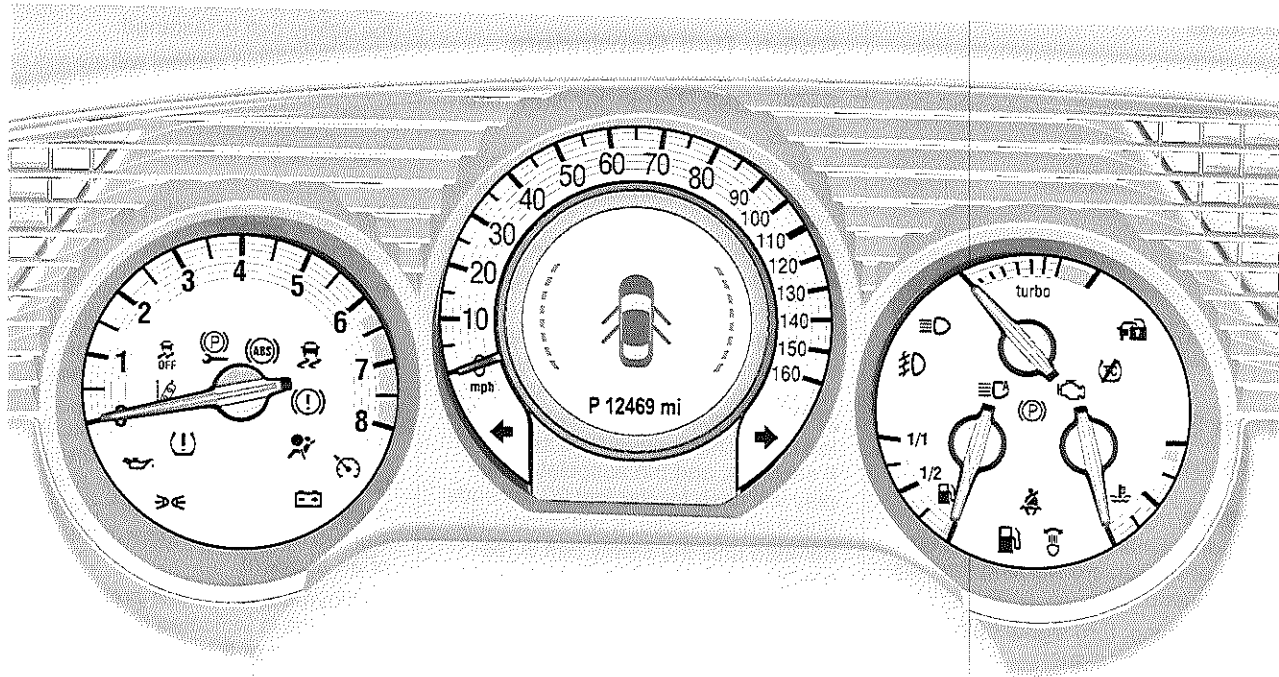

Control indicators in the roof console

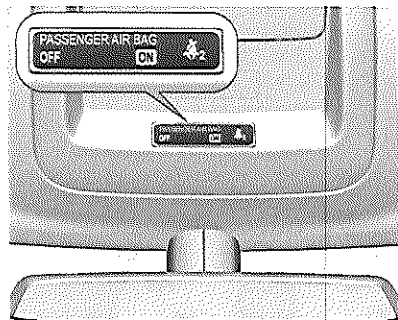

Turn Signal

↔ flashes green.

Flashes

The control indicator flashes if a turn signal or the hazard warning flashers are activated.

Rapid flashing: turn signal bulb or fuse failure, turn signal bulb failure on trailer.

Bulb replacement ↗ 176. Fuses ↗ 182.

Turn signals ↗ 127.

Safety Belt Reminders

Safety Belt Reminder on Front Seats

⚠ for driver's seat is located in main instrument and illuminates or flashes red.

⚠² for front passenger seat is located in the roof console and illuminates or flashes red.

When the ignition is on or the engine is running, the safety belt reminder will initiate within 1 second if the driver and/or the passenger have not buckled up. A chime sound will sound for 6 seconds, and the associated display will flash for the first 20 seconds and then turn solid. It will remain illuminated until the safety belt is fastened.

If not buckled up when driving off, a reminder will be initiated when the vehicle speed exceeds 14 mph or the driving distance exceeds 820 ft.

A chime sound will sound for 6 sec-

onds, and the associated display will flash for the first 20 seconds, or until the safety belt is fastened.

The associated symbol will always be illuminated when a safety belt is not used.

Fastening the safety belt ↗ 43.

Airbag and Belt Tensioner Light

⚠ illuminates red.

When the ignition is switched on, the control indicator illuminates for approx. 4 seconds. If it does not illuminate, does not go out after 4 seconds, or illuminates while driving, there is a fault in the airbag system. Seek the assistance of a workshop. The airbags and belt pretensioners may fail to trigger in the event of an accident.

Deployment of the belt pretensioners or airbags is indicated by continuous illumination of ⚠.

⚠ Warning

Have the cause of the fault remedied immediately by a workshop.

Belt pretensioners, airbag system
 ⇨ 40, ⇨ 46.

Seat Occupancy Recognition Light

Passenger airbag status indicators in the roof console.

The vehicle has a passenger sensing system ⇨ 57.

When the vehicle is started, the passenger airbag status indicator will illuminate the symbols **on** and **off** for several seconds as a system check.

If the **on** symbol is lit on the passenger airbag status indicator, it means that the right front passenger frontal airbag is enabled (may inflate).

If the **off** symbol is lit on the airbag status indicator, it means that the passenger sensing system has turned off the right front passenger frontal airbag.

If, after several seconds, both status indicator lights remain on, or if there are no lights at all, there may be a problem with the lights or the passenger sensing system. Consult your dealer for service.

⚠ Warning

If the airbag indicator light  ever comes on and stays on, it means that something may be wrong with the airbag system. To help avoid injury to yourself or others, have the vehicle serviced right away.

Airbag indicator light ⇨ 98.

Charging System Light

 illuminates red.

Illuminates when the ignition is switched on and goes out shortly after the engine starts.

Illuminates when the engine is running

Stop, switch off engine. Battery is not charging. Engine cooling may be interrupted. The brake servo unit may stop working. Seek the assistance of a workshop.

Malfunction Indicator Lamp

 illuminates or flashes yellow.

Illuminates when the ignition is switched on and goes out shortly after the engine starts.

Illuminates when the engine is running

Fault in the fuel, ignition or emission control system. The permitted emission limits may be exceeded. Seek the assistance of a workshop immediately.

Flashes when the engine is running

Fault that could lead to catalytic converter damage. Ease up on the accelerator until the flashing stops. Seek the immediate assistance of a workshop.

Brake System Warning Light

ⓘ illuminates red.

This light should come on briefly when ignition is switched on. If it doesn't come on, have it fixed so it will be ready to warn you if there is a problem. This light indicates when the brake fluid level is too low ⇨ 174.

⚠ Warning

Stop. Do not continue your journey. Consult a workshop.

Electrical Parking Brake Light

Ⓢ illuminates or flashes red.

Flashes twice and then illuminates

Electrical parking brake is applied ⇨ 151.

Flashes continuously

Electrical parking brake is not fully applied or released. Depress the foot brake pedal and attempt to reset the system by first releasing and then applying the electrical parking brake. If Ⓢ remains flashing, do not drive and seek the assistance of a workshop.

Electrical Parking Brake Fault Light

Ⓢ illuminates or flashes yellow.

illuminates

Electric parking brake is operating with degraded performance ⇨ 151.

Flashes

Electric parking brake is in service mode. Stop vehicle and apply and release the electric parking brake to reset.

⚠ Warning

Have the cause of the fault remedied immediately by a workshop.

Antilock Brake System (ABS) Warning Light

Ⓢ illuminates yellow.

Illuminates for a few seconds after the ignition is switched on. The system is ready for operation when the control indicator goes out.

If the control indicator does not go out after a few seconds, or if it illuminates while driving, there is a fault in the ABS. The brake system remains operational but without ABS regulation.

Antilock Brake System ⇨ 150.

Lane Departure Warning (LDW) Light

Ⓢ illuminates green or flashes yellow.

Illuminates green

System is switched on and ready to operate.

Flashes Yellow

System recognizes an unintended lane change.

Not illuminated, if no marking is detected or speed less than 37 mph.

Electronic Stability Program (ESP) Light

⚡ illuminates or flashes yellow.

Illuminates

A system fault has occurred. Continued driving is possible. Driving stability, however, may deteriorate depending on road surface conditions.

Have a repair shop fix the cause of the fault.

Flashes

The system is actively engaged. Engine output may be reduced and the vehicle brake automatically to a small degree.

Electronic Stability Program Off Light

⚡ illuminates yellow.

Illuminates when the system is deactivated.

Deactivation ⇨ 153.

Traction Control System Off Light

⚡ illuminates yellow.

Illuminates when the system is deactivated.

Deactivation ⇨ 153.

Tyre Pressure Monitoring System Light

Ⓣ illuminates or flashes yellow.

Illuminates

Tire pressure below recommended placard value, check and adjust tire pressure. Tire messages are also indicated in the Driver Information Center (DIC). The recommended tire pressure is even stated on a label on the front left door frame.

Flashes

Fault in system or wheel without pressure sensor mounted (e.g. full-size spare tire). After 60 - 90 seconds the control indicator remains illuminated. Consult a workshop.

Engine Oil Pressure Light

⚡ illuminates red.

Illuminates when the ignition is switched on and goes out shortly after the engine starts.

Illuminates when the engine is running

Caution

Engine lubrication may be interrupted. This may result in serious damage to the engine.

1. Set gear shift lever to N.
2. Move out of the flow of traffic as quickly as possible without impeding other vehicles.
3. Switch off ignition.

Warning

When the engine is off, considerably more force is needed to brake and steer.

Check oil level before seeking assistance of a repair shop ⇨ 172.

Low Fuel Warning Light

 illuminates yellow.

Illuminates when level in fuel tank is too low.

Catalytic converter ⇨ 146.

Immobilizer Light

 flashes yellow.

Fault in the electronic immobilizer system. The engine cannot be started.

Headlamps

 illuminates green.

Illuminated when the headlamps are on ⇨ 124.

 illuminates green.

Illuminated when high beam assist is switched on ⇨ 125.

High-Beam On Light

 illuminates blue.

Illuminated when high beam is on or headlamps are in flasher mode ⇨ 125.

Adaptive Forward Lighting (AFL) Light

Dynamic curve lighting

 illuminates yellow if there is a fault in the system.

Seek the assistance of a workshop.

Dynamic curve lighting, Dynamic automatic headlamp leveling ⇨ 125.

Fog Lamp Light

 illuminates green.

Illuminated when the front fog lamps are on ⇨ 127.

Cruise Control Light

 illuminates white or green.

Illuminates white

The system is on, but not activated.

Illuminates green

The system is activated.

Cruise control ⇨ 156.

Door Ajar Light

☼ illuminates in the display of the Driver Information Center.

Illuminates a pop-up warning when a door or the trunk lid is open in driving mode.

With vehicle standing still, an open door will be indicated as a small symbol.

Information Displays

Driver Information Center (DIC)

The Driver Information Center (DIC) is located in the instrument cluster in the middle of the speedometer. It is available as a monochrome or color display. The following descriptions are valid for both versions.

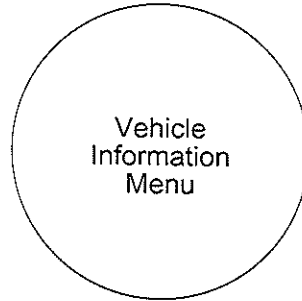

The following main menus can be selected, depending on the vehicle configuration:

- Trip/Fuel Information Menu
- Vehicle Information Menu

Some of the displayed functions differ between driving and standstill mode, and some functions are only active when the vehicle is in driving mode.

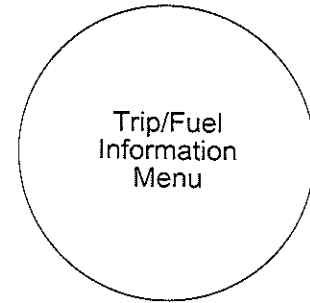

Vehicle personalization ☐ 114. Memorized settings ☐ 18.

Selecting Menus and Functions

The menus and functions can be selected via the buttons on the turn signal lever.

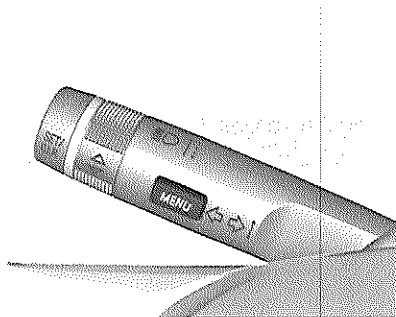

Press the **MENU** button to switch between the menus or to return from a submenu to the next higher menu level.

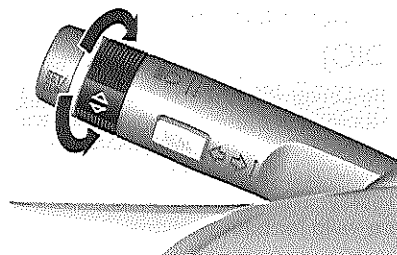

Turn the adjuster wheel to change a page or to set a numeric value.

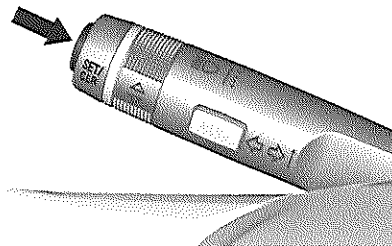

Press the **SET/CLR** button to select a function or to confirm a message.

Trip/Fuel Information Menu

Switch on ignition.

If not displayed, press the **MENU** button to select the **Trip/Fuel Information Menu**.

Turn the adjuster wheel to select one of the Trip Computer submenus. Press the **SET/CLR** button to confirm if required.

Trip Computer submenus can be:

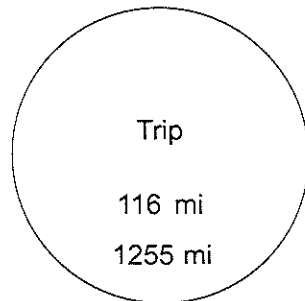

- Speed
- Trip

- Range
 - Avg. Consumption / Inst. consumption
 - Avg. Speed
 - Distance / Estimated time of arrival
 - Navigation
 - "Blank page" without information, only mileage shown
- Trip Computer ⇨ 112.

Indication can be different between monochrome and color display.

Vehicle Information Menu

When the ignition is switched on, **Trip/Fuel Information Menu** will always appear first.

Press the **MENU** button to select the **Vehicle Information Menu**.

Turn the adjuster wheel to select one of the subpages. Press the **SET/CLR** button to confirm.



Follow the instructions given in the pages.

Pages can be:

- **Unit:** Displayed units can be changed.
- **Speed Warning:** If the preset speed is exceeded, a warning chime will be activated.
- **Battery Voltage:** Display of battery voltage.
- **Remaining Oil Life:** Display of remaining oil life duration ⇨ 95.

- **Tire Pressure:** Displays tire pressure for all wheels ⇨ 199.
- **Compass:** Compass settings ⇨ 91. Indication can be different between monochrome and color display.

Graphic Information Display (GID) and Color Information Display (CID)

Depending on the vehicle configuration, the vehicle has a Graphic Information Display or Color Information Display with Touchscreen functionality. The display is located in the instrument panel above the faceplate of the Infotainment system.

To enter the setup menu for both displays, press the button **CONFIG**.

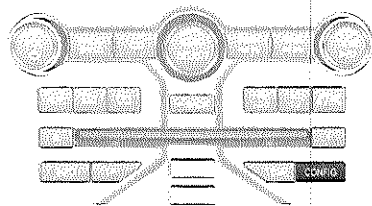

System Settings, Personalization
 ↻ 114.

Graphic Information Display



The Graphic Information Display indicates:

- time ↻ 91
- outside temperature ↻ 90
- date ↻ 91
- Infotainment system, see description for Infotainment system
- settings for vehicle personalization ↻ 114

Selecting Menus and Settings with the Multifunction Knob Menu/Select

Menus and settings are accessed via the display.

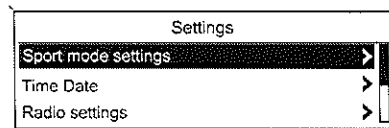

Selections are made via:

- menus
- Infotainment system function buttons and multifunction knob

Multifunction Knob Menu/Select

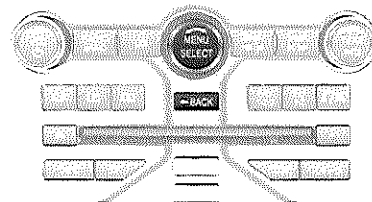

Select a function via the Infotainment system buttons. The menu for the selected function is displayed.

The multifunction knob is used to select and confirm an item.

Turn the multifunction knob

- To mark a menu option
- To set a numeric value or to display a menu option

Press the multifunction knob

- To select or activate the marked option
- To confirm a set value
- To switch a system function on/off
- To bring up a context-sensitive menu.

BACK button

Press button to:

- exit a menu without changing settings
- return from a submenu to a higher menu level
- delete the last character in a character sequence

Press and hold the button for a few seconds to delete the entire entry.

Vehicle personalization ↻ 114.

Memorized settings in the remote control ↻ 18.

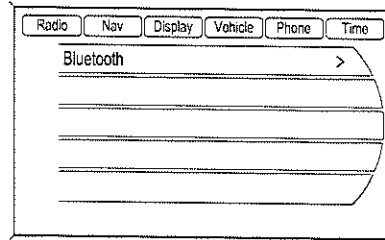
Color Information Display with Touchscreen Functionality

The Color Information Display is a touchscreen display and indicates in color:

- time ↻ 91
- outside temperature ↻ 90
- date ↻ 91
- Infotainment system, see description for Infotainment system
- navigation, see description for Infotainment system
- system settings

- vehicle messages ↻ 111
- settings for vehicle personalization ↻ 114

The type of information and how it is displayed depend on the equipment of the vehicle and the settings made.

Selecting Menus and Settings with the Touch Buttons on the Display

To scroll through the available setup options, press the **CONFIG** button repeatedly, or touch the corresponding buttons on the display.

Selecting Menus and Settings with the Multifunction Knob Menu/Select, see description for **Graphic Information Display** above.

Head-Up Display (HUD)

The Head-up display (HUD) projects the following information concerning the operation of the vehicle onto the windshield:

- speedometer reading
- tachometer reading

- automatic transmission selector lever position
- tap shift gear
- outside air temperature
- compass heading
- turn-by-turn navigation information if the vehicle has a navigation radio.

The images are projected through the HUD lens located on the driver's side of the instrument panel.

Notice

Do not try to use the HUD image as a parking aid, you may misjudge the distance and damage your vehicle.

The HUD information is displayed in the language which is set in the personal settings of the Info Display. Vehicle personalization ↻ 114. Not all languages are included in the Head-up display.

The speedometer reading and other numerical values can be displayed in either English or metric units. The language selection can be changed using the Infotainment System. The units of measurement can be

changed in the trip computer in the Driver Information Center (DIC) ↻ 103.

⚠ Warning

If the HUD image is too bright or too high in your field of view, it may obstruct your view when it is dark outside. Be sure to keep the HUD image dim and placed low in your field of view.

Display on the vehicle windshield

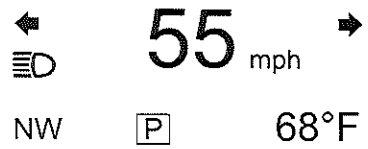

The HUD information appears as an image focused out toward the front of the vehicle. When the ignition is switched on, the HUD will display an introductory message for a short time, until the HUD is ready. The following indicator lights come on the instrument panel when activated and also appear on the HUD:

- Turn signal indicators
- High-beam on light

The HUD temporarily displays some vehicle warnings and messages when these messages are on the DIC trip computer.

- Check tire pressure
- Fuel level low
- Traction Control System (TCS)
- Electronic Stability Control (ESC) Indicator Light
- Front parking assist

The HUD control is located to the left of the steering wheel. To adjust the HUD image so that items are properly displayed, do the following steps:

1. Adjust the driver's seat to a comfortable position.
2. Start the engine.
3. Adjust the HUD controls, use the following settings:

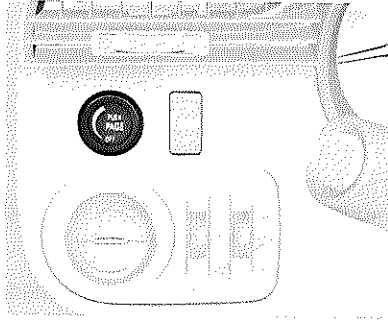

OFF: To turn HUD off, turn the HUD dimming knob fully counterclockwise until the HUD display turns off.

Brightness: Turn the dimming knob clockwise or counterclockwise to brighten or dim the display.

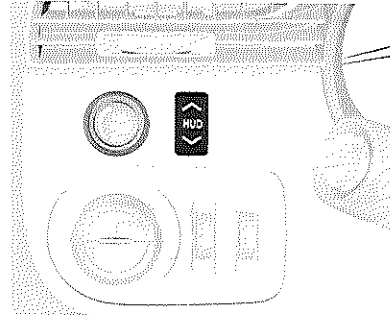

^ Up v Down:

Press the up or down arrows to center the HUD image in your view. The HUD image can only be adjusted up and down, not side to side.

PAGE: Press to select the display formats. Release the page button when the format number with the desired display is shown on the HUD. If vehicle messages are displayed, pressing **PAGE** may clear the message.

The three formats are as follows:

Format One

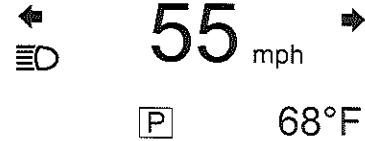

This display indicates the speedometer reading (in imperial or metric units), turn signal indication, high-beam on light, transmission positions and outside air temperature and compass heading.

Format Two



This display includes the information in Format One without the transmission information and outside air temperature and compass heading.

Format Three

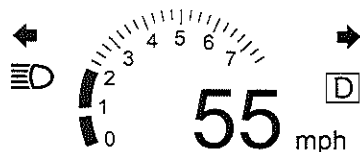

This display includes all the information in Format One along with a circular tachometer, but without outside air temperature and compass heading.

All formats will show the turn-by-turn navigation information and provide details about the next driving maneuver to be made. The HUD will display a distance bar that will empty the closer you get to your maneuver. All navigation information is provided to the HUD by the navigation radio or OnStar® service, for vehicles that have these features.

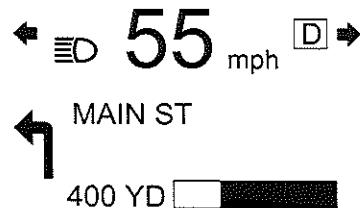

The HUD image displayed on the windshield will automatically dim and brighten to compensate for outside lighting. However, the HUD brightness can still be adjusted as needed.

The HUD image can temporarily light up depending on the angle and position of the sunlight on the HUD display. This is normal and will change when the angle of the sunlight on the HUD display changes. Polarized sunglasses could make the HUD image harder to see.

Vehicle Messages

Messages are indicated in the Driver Information Center (DIC), in some cases together with a warning and an audible signal.

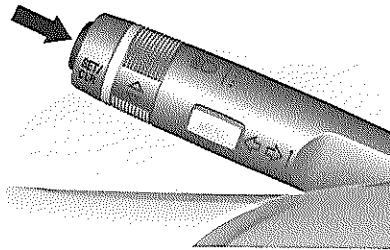

Press the **SET/CLR** button to confirm a message.

Vehicle messages on the Driver Information Center (DIC)

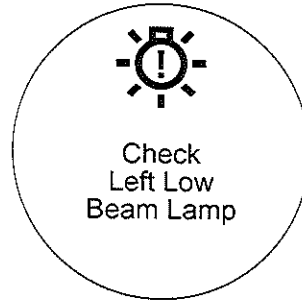

The vehicle messages are displayed as text. Follow the instructions given in the messages.

The system displays messages regarding the following topics:

- Fluid levels
- Anti-theft alarm system
- Brakes
- Drive systems
- Ride control systems
- Cruise control

- Object detection systems
- Lighting, bulb replacement
- Wiper/washer system
- Doors, windows, engine hood open
- Remote control
- Safety belts
- Airbag systems
- Engine and transmission
- Tire pressure
- Service vehicle soon
- Steering column lock
- Parking assist
- Apply footbrake
- Variable effort steering
- Remote control battery change

Warning Buzzers

When starting the engine or while driving

- If safety belt is not fastened
- If a door or the trunk lid is not fully closed when starting off

- If a programmed speed is exceeded
- If a warning message appears in the Driver Information Center (DIC)
- If the parking assist detects an object
- When remote control is missing in the vehicle

When the vehicle is parked and/ or the driver's door is opened

- With exterior lights on
- When remote control is forgotten in the vehicle

Battery Voltage and Charging Messages

In case of low battery voltage, the charging of the battery is monitored and continuously adapted to optimize battery state of charge, fuel economy, headlamp and wiper performance. The current battery voltage is displayed on the Driver Information Center (DIC), **Vehicle Information Menu, Battery Voltage**, reflecting these charging cycles in different voltages.

If the battery voltage is running low, a warning message will appear in the Driver Information Center (DIC).

1. Switch off immediately electrical consumers which are not required for a safe ride, such as seat heating, heated rear window or other main consumers.
2. Charge the battery by driving continuously for a while or by using a charging device.

The warning message will disappear after the engine has been started two times running without voltage drop.

If the battery cannot be recharged, have the cause of the fault remedied by a workshop.

Trip Computer

The menus and functions can be selected via the buttons on the turn signal lever.

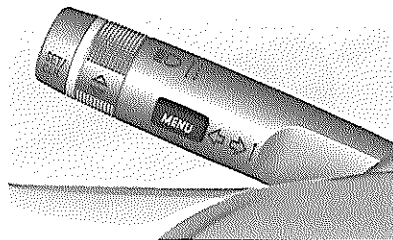

Press the **MENU** button to select the **Trip/Fuel Information Menu**.

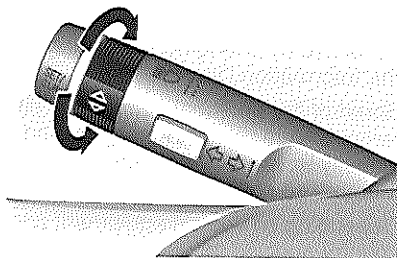

Turn the adjuster wheel to select a submenu.

Follow the instructions in the submenu:

Speed

Display of the current digital speed in the chosen unit.

Trip Odometer

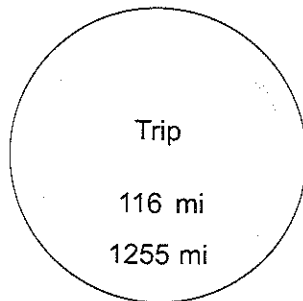

Displays the recorded distance since the last reset.

To reset, press the **SET/CLR** button for a few seconds.

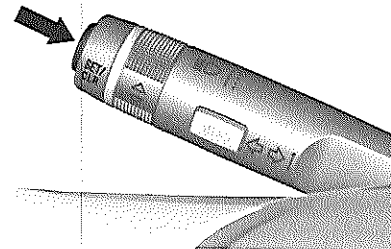

Range

Range is calculated from current fuel tank content and current consumption. The display shows average values.

After refuelling, the range is updated automatically after a brief delay.

When the fuel level in the tank is low, a message appears in the Driver Information Center and in the Information Display.

Additionally, the  control indicator in the fuel gauge illuminates.

Average Consumption / Instantaneous Consumption

Display of average consumption and instantaneous consumption. The measurement of average consumption can be reset at any time.

To reset, press the **SET/CLR** button for a few seconds.

Average Speed

Display of average speed. The measurement can be reset at any time.

To reset, press the **SET/CLR** button for a few seconds.

Distance and Estimated Time of Arrival

Display of distance and corresponding arrival time. The measurement can be reset at any time.

To use the distance function and get a calculated estimated time of arrival, press the **SET/CLR** button briefly and turn the adjuster wheel to set the distance to the destination.

Press the **SET/CLR** button to show estimated time of arrival.

Estimated time of arrival is updated during the trip based on the average speed since distance was set.

When distance reaches zero, the function acts as trip odometer. The trip odometer starts from the distance that was set previously.

To reset all values, press the **SET/CLR** button for a few seconds.

Navigation

Display of additional route guidance and hints to the navigation system.

"Blank page"

indicates no further content except kilometrage/mileage.

Vehicle Personalization

Certain vehicle functions can be personalized by changing the settings in the Information Display.

Some of the personal settings for different drivers can be memorized individually for each remote control.

Memorized settings ↻ 18

Depending on vehicle equipment and country-specific regulations, some of the functions described below might not be available.

Vehicle information is only displayed in Ignition on mode (green LED in **Start/Stop** button illuminated).

Personal Settings in the Graphic Information Display

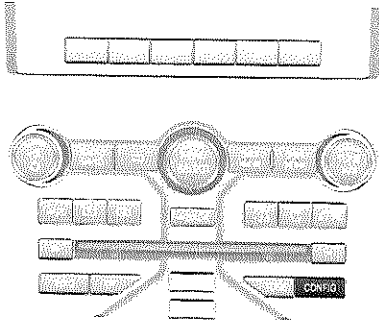

Press the **CONFIG** button. The **Settings** menu is displayed.

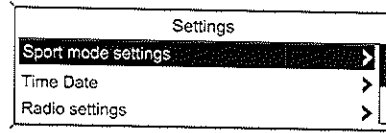

20325

The following settings can be selected by turning and pushing the multifunction knob:

- **Sport mode settings**
- **Time Date**
- **Radio settings**
- **Phone settings**
- **Vehicle settings**
- **Restore factory settings**

In the corresponding submenus, the following settings can be changed:

Sport mode settings

The functions which will be activated in Sport mode can be selected in **Sport mode settings** \diamond 154.

- **Sport suspension:** Shock absorbers becomes stiffer.
- **Sport steering:** Steering support reduced.
- **Sport Cross-Wheel-Drive:** More engine torque is distributed to the rear axle.

Time Date

See Clock \diamond 91.

Radio settings

See description for Infotainment system.

Phone settings

See description for Infotainment system.

Vehicle settings

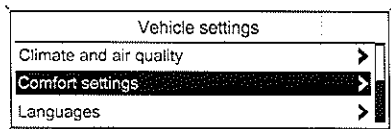

20326

■ **Climate control and air quality**

Auto fan speed: Modifies fan regulation.

Climate control mode: Activate or deactivate cooling or select previous settings.

Temperature zone at start: Change between single zone or dual zone temperature setting.

Auto defogger: Supports windshield defogging by forcing outside air and auto air conditioning mode.

Auto rear defogger: Automatic activation of rear heated window.

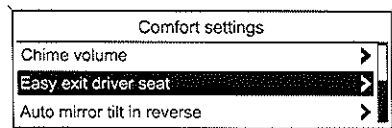

20327

■ **Comfort settings**

Chime volume: Change the volume of warning chimes.

Conf. closing mirror fold: Activate or deactivate the automatic mirror folding function while comfort closing.

Auto mirror tilt in reverse: Activate or deactivate the parking assist function of the exterior mirrors.

Personalization by driver: Activate or deactivate the personalization function.

■ **Languages**

Selection of the desired language.

■ **Exterior ambient lighting**

Exterior lighting by unlocking: Activate or deactivate welcome lighting.

Duration upon exit of vehicle: Activate or deactivate and change the duration of exit lighting.

■ **Remote locking, unlocking, starting**

Remote unlock feedback: Activate or deactivate the hazard warning flasher feedback while unlocking.

Remote door unlock: Change the configuration to unlock only the driver's door or the whole vehicle while unlocking.

■ **Restore factory settings**

Restore factory settings: Reset all settings to the default settings.

Personal Settings in the Color Information Display with Touchscreen Functionality

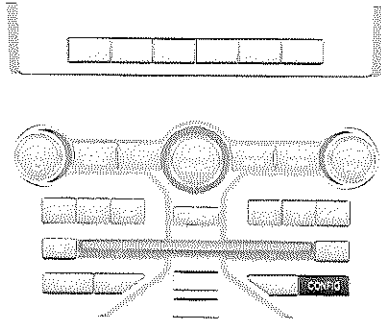

The setup menu is used for changing the screens for the audio, navigation display, phone, vehicle configuration, and time features. Press the **CONFIG** button to display the setup menu.

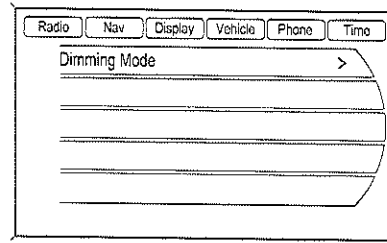

The following settings can be selected by scrolling through the setup options, either by pressing one of the screen buttons at the top, or pressing the **CONFIG** button repeatedly, or turning and pushing the multifunction knob:

- **Sport**
- **Time**
- **Radio**
- **Phone**
- **Nav**
- **Vehicle**

- **Display**
- **Return to Factory Settings**

In the corresponding submenu, the following settings can be changed:

Sport

The functions which will be activated in Sport mode can be selected
 ⇨ 154.

- **Sport Suspension:** Shock absorbers becomes stiffer.
- **Sport Steering:** Steering support reduced.
- **All Wheel Drive:** More engine torque is distributed to the rear axle.
- **Return to Factory Settings:** Reset all functions to factory settings.

Time

See Clock ⇨ 91.

Radio

See description for Infotainment system.

Phone

See description for Infotainment system.

Nav

See description for Infotainment system.

Vehicle

■ **Climate and Air Quality**

Auto Fan Speed: Modifies fan regulation.

Air Conditioning Mode: Activate or deactivate cooling or select previous settings.

Auto Defog: Supports windshield defogging by forcing outside air and auto air conditioning mode.

Auto Rear Defog: Automatic activation of rear heated window.

■ **Comfort and Convenience**

Chime Volume: Change the volume of warning chimes.

Auto Mirror Folding: Activate or deactivate the automatic mirror folding function while comfort closing.

Reverse Tilt Mirror: Activate or deactivate the parking assist function of the exterior mirrors.

■ **Languages**

Selection of the desired language.

■ **Lighting**

Vehicle Locator Lights: Activate or deactivate welcome lighting.

Exit Lighting: Activate or deactivate and change the duration of exit lighting.

■ **Remote Locking, Unlocking, Starting**

Door Unlock: Change the configuration to unlock only the driver's door or the whole vehicle while unlocking.

Memory Remote Recall: Activate or deactivate the personalization function.

■ **Return to Factory Settings**

Return to Factory Settings: Reset all settings to the default settings.

Display

Selectable display settings:

■ **Day Mode:** Optimization for daylight conditions.

■ **Night Mode:** Optimization for darkness.

■ **Auto Mode:** The display changes mode depending on outside surrounding light or, on some versions, daytime running lamps / headlamps are always on

OnStar® System

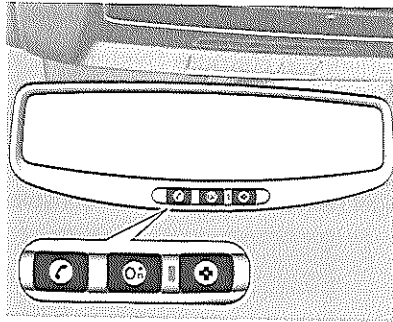

OnStar® uses several innovative technologies and live advisors to provide a wide range of safety, security, navigation, diagnostics, and calling services.

Automatic Crash Response

In a crash, built-in sensors can automatically alert an OnStar® advisor, who is immediately connected to the vehicle to see if you need help.

How OnStar® Service Works

On: This blue button connects you to a specially trained OnStar® advisor to verify your account information and to answer questions.

: Push this red emergency button to get priority help from specially trained OnStar® emergency advisors.

: Push this button for hands-free, voice-activated calling and to give voice commands for turn-by-turn navigation.

Crisis Assistance, Stolen Vehicle Assistance, Vehicle Diagnostics, Remote Door Unlock, Roadside Assistance, Turn-by-Turn Navigation, and Hands-Free Calling are available on most vehicles. Not all OnStar® services are available on all vehicles.

For more information, see the OnStar® Owner's Guide or visit www.onstar.com, contact OnStar at 1-888-4-ONSTAR (1-888-466-7827), or press **On** to speak with an OnStar® advisor 24 hours a day, 7 days a week.

For a full description of OnStar® services and system limitations, see the OnStar® Owner's Guide.

OnStar® service is subject to the OnStar terms and conditions included in the OnStar® Subscriber Information.

OnStar® service cannot work unless the vehicle is in a place where OnStar® has an agreement with a wireless service provider for service in that area. OnStar® service also cannot work unless the vehicle is in a place where the wireless service provider OnStar® has hired for that area has coverage, network capacity, and reception when the service is needed, and technology that is compatible with the OnStar® service. Not all services are available everywhere, particularly in remote or enclosed areas, or at all times.

The OnStar® system can record and transmit vehicle information. This information is automatically sent to an OnStar® call center when **On** is

pressed,  is pressed, or if the air-bags or ACR system deploy. This information usually includes the vehicle's GPS location and, in the event of a crash, additional information regarding the crash that the vehicle was involved in (e.g., the direction from which the vehicle was hit). When the virtual advisor feature of OnStar[®] hands-free calling is used, the vehicle also sends OnStar[®] the vehicle's GPS location so they can provide services where it is located.

Location information about the vehicle is only available if the GPS satellite signals are unobstructed and available.

The vehicle must have a working electrical system, including adequate battery power, for the OnStar[®] equipment to operate. There are other problems OnStar[®] cannot control that may prevent OnStar[®] from providing OnStar[®] service at any particular time or place. Some examples are damage to important parts of the vehicle in a crash, hills, tall buildings, tunnels, weather, or wireless phone network congestion.

OnStar[®] Steering Wheel Controls

This vehicle may have a Talk/Mute button that can be used to interact with OnStar[®] hands-free calling.

On some vehicles, the mute button can be used to dial numbers into voice mail systems, or to dial phone extensions. See the OnStar[®] Owner's Guide for more information.

Your Responsibility

Increase the volume of the radio if the OnStar[®] advisor cannot be heard.

If the indicator light next to the OnStar[®] button is red, the system may not be functioning properly. Press **On** and request a vehicle diagnostic. If the indicator light is clear (not illuminated), your OnStar[®] subscription has expired and all services have been deactivated.

Press **On** to confirm that the OnStar[®] equipment is active.

Universal Remote System

Universal Remote System Programming

If the vehicle has this feature, you will see these buttons with one square Light Emitting Diode (LED) indicator light next to them in the roof console.

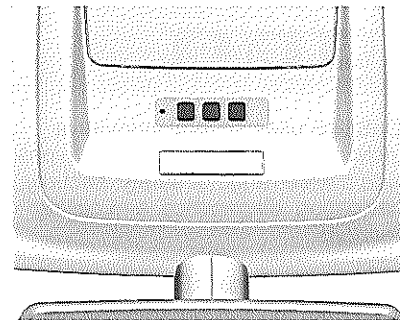

This system provides a way to replace up to three remote control transmitters used to activate devices

such as garage door openers, security systems, and home automation devices.

Do not use the Universal Home Remote with any garage door opener that does not have the stop and reverse feature. This includes any garage door opener model manufactured before April 1, 1982.

Read the instructions completely before attempting to program the Universal Home Remote. Because of the steps involved, it may be helpful to have another person available to assist you with programming the Universal Home Remote.

Keep the original handheld transmitter for use in other vehicles, as well as for future Universal Home Remote programming. It is also recommended that upon the sale of the vehicle, the programmed Universal Home Remote buttons should be erased for security purposes. See "Erasing Universal Home Remote Buttons" later in this section.

When programming a garage door, park outside of the garage. Park directly in line with and facing the garage door opener motor head or gate motor head. Be sure that people and objects are clear of the garage door or gate that is being programmed.

It is recommended that a new battery be installed in your handheld transmitter for quicker and more accurate transmission of the radio frequency signal.

Programming the Universal Home Remote System

For questions or help programming the Universal Home Remote System, call 1-800-355-3515 or go to www.homelink.com.

Programming a garage door opener involves time-sensitive actions, so read the entire procedure before starting. Otherwise, the device will time out and the procedure will have to be repeated.

To program up to three devices:

1. Hold the end of your handheld transmitter about one to three inches away from the Universal Home Remote buttons while keeping the indicator light in view. The handheld transmitter was supplied by the manufacturer of your garage door opener receiver (motor head unit).
2. At the same time, press and hold both the handheld transmitter button and one of the three Universal Home Remote buttons to be used to operate the garage door. Do not release the Universal Home Remote button or the handheld transmitter button until the indicator light changes from a slow to a rapidly flashing light. You now may release both buttons.
3. Press and hold the newly trained Universal Home Remote button (selected button from Step 2) for five seconds while observing the indicator light and garage door activation.

If the indicator light stays on continuously or the garage door starts to move when the Universal Home Remote button is pressed and released, then programming is complete. There is no need to continue programming Steps 4 through 6.

If the Universal Home Remote indicator light blinks rapidly for two seconds, then turns to a constant light and the garage door does not move, continue with programming Steps 4 through 6. It may be helpful to have another person to assist with the remaining Steps 4 through 6.

4. After Steps 1 through 3 have been completed, locate the "Learn" or "Smart" button inside the garage on the garage door opener receiver (motor head unit). The name and color of the button may vary by manufacturer.

5. Firmly press and release the "Learn" or "Smart" button. After you press this button, you will have 30 seconds to complete Step 6.
6. Immediately return to the vehicle. Firmly press and hold the Universal Home Remote button selected in Step 2 to control the garage door; hold it for two seconds, and then release. If the garage door does not move or the light on the garage door opener receiver (motor head unit) does not flash, press and hold the same button again for two seconds, and then release. Again, if the door does not move or the garage door light does not flash, press and hold the same button a third time for two seconds, and then release.

The Universal Home Remote should now activate the garage door. To program the remaining two Universal Home Remote buttons, begin with Step 1 of "Programming the Universal Home Remote System".

Universal Remote System Operation

Using Universal Home Remote

Press and hold the appropriate Universal Home Remote button for at least half a second. The indicator light will come on while the signal is being transmitted.

Erasing Universal Home Remote Buttons

All programmed buttons should be erased when the vehicle is sold or the lease ends. To erase all programmed buttons on the Universal Home Remote device:

1. Press and hold down the two outside buttons until the indicator light begins to flash, after 10 seconds.
2. Release both buttons.

Reprogramming a Single Universal Home Remote Button

To reprogram any of the three Universal Home Remote buttons:

1. Press and hold the desired Universal Home Remote button. Do not release the button.
2. The indicator light will begin to flash after 20 seconds. Without releasing the button, proceed with Step 1 of the section "Programming Universal Home Remote."

If you have questions or need help programming the Universal Home Remote System, call 1-800-355-3515 or go to www.homelink.com.

Lighting

Exterior Lighting 124
 Interior Lighting 128
 Lighting Features 131

Exterior Lighting Exterior Lamp Controls

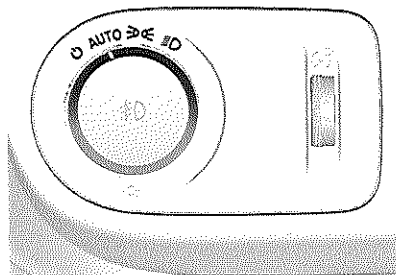

- Turn exterior lamp control:
- ☉ = Activate or deactivate automatic light control. Switch turns back to **AUTO**.
 - AUTO** = Automatic light control: Headlamps are switched on and off automatically depending on outside lighting conditions.
 - ☛☛ = Parking lamps
 - ☛☛☛ = Headlamps

The current status of the automatic light control system is displayed for 3 seconds in the Driver Information Center.

If exterior lamp control is turned to **AUTO**, automatic light control is active when the ignition is switched on.

Country-specific version: In some countries, the headlamps are always on in position **AUTO**.

Control indicator ☛☛ ☛ 102.

Taillamps

Taillamps are at the same time as the headlamps and parking lamps.

Automatic Light Control

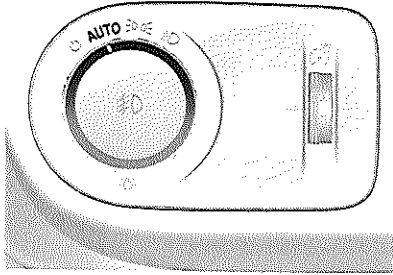

Automatic Light Control Function

When the automatic light control function is switched on and the engine is running, the system switches between daytime running lamps and headlamps depending on the lighting conditions.

Daytime Running Lamps

Daytime running lamps increase visibility of the vehicle during daylight. Taillamps are not on.

Automatic Headlight Activation

Under poor lighting conditions, the headlamps are switched on.

Tunnel Detection

When entering a tunnel, the headlamps switch on immediately.

Adaptive forward lighting ⇨ 125.

Headlamp High/Low-Beam Changer

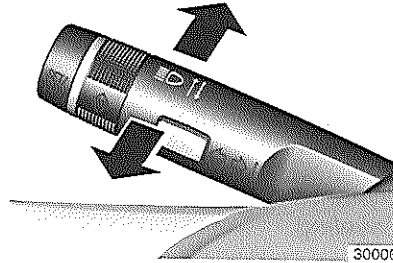

To switch from low to high beam, push lever.

To switch to low beam, push lever again or pull.

Flash-to-Pass



To activate flash-to-pass, pull lever.

Adaptive Forward Lighting (AFL)

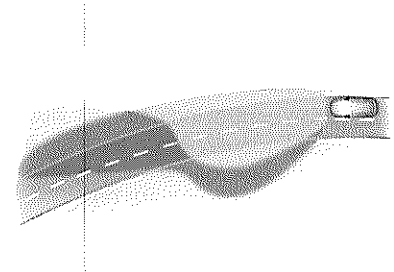
Dynamic Curve Lighting





The headlamp beam pivots based on steering wheel angle and speed, improving lighting in curves.

Control indicator  illuminates in the case of a failure  102.

High Beam Assist

High beam assist is activated by pushing the headlamp lever twice.

This feature allows the high beams to serve as the main driving lights at night when vehicle speed is faster than 25 mph and streetlights are not detected. It switches to low beam when the camera in the windshield detects the lights of oncoming or preceding vehicles. If there are no restrictions detected, the system switches back to high beam.

The green control indicator  illuminates continuously when assist is activated; the blue one  illuminates when the high beams are on.

Control indicator   102.

If flash-to-pass is activated when the high beams are on, high beam assist will be deactivated.

If flash-to-pass is activated when the high beams are off, high beam assist will stay activated.

To deactivate, push headlamp lever once.

The most recent high beam assist setting will be in effect after the ignition is switched on the next time.

Disabling High Beam Assist under Fog Conditions



This feature disables the automatic control of the high beams to avoid creating glare for oncoming vehicles when fog is detected. It can last for up to 10 minutes until the system actually turns off.

Once it is turned off, switch on high beam assist manually by pushing the headlamp lever twice.

Other poor weather conditions, like rain, can influence the performance of the system.

Dynamic Automatic Headlight Leveling

To avoid creating glare for oncoming traffic, headlight leveling is automatically adjusted.

Control indicator  illuminates in the case of a failure  102.

Hazard Warning Flashers

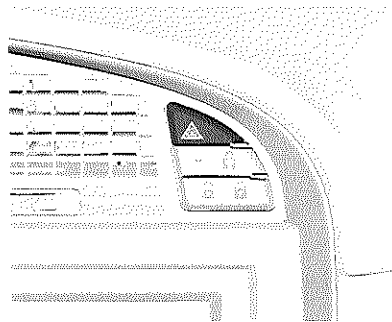

Operated with the  button.

Press again to turn the flashers off.

In the event of an accident with airbag deployment, the hazard warning flashers are activated automatically.

Warning

Switch on the hazard flashers if the car has to be left at the roadside on account of a collision, engine trouble or a flat tire.

If you carry a warning triangle or flares, they should be set up along the side of the road 50-110 yds behind your vehicle. If the car is not clearly visible (e.g. over the crest of a hill or bridge), position the triangle/flare even further back.

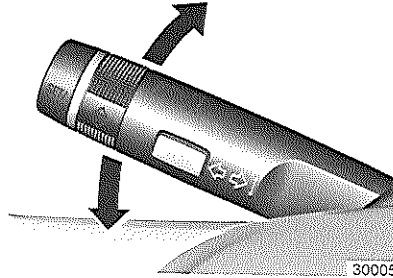
Turn and Lane-Change Signals

Lever up = right turn signal
Lever down = left turn signal

If the lever is moved past the resistance point, the turn signal is switched on constantly. When the steering wheel moves back, the turn signal is automatically deactivated.

For three flashes (e.g., when changing lanes), press the lever until resistance is felt and then release.

If a trailer is hitched, the turn signal flashes six times when the lever is pressed until resistance and then released.

For a longer signal, move the lever to the resistance point and hold.

Switch the turn signal off manually by moving the lever to its original position.

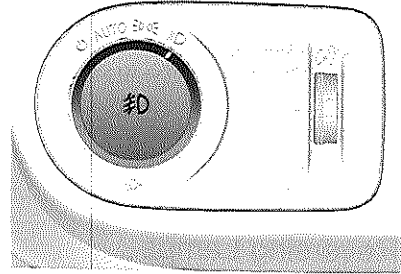
Front Fog Lamps

Operated with the D button.

Exterior lamp control in Auto position: switching on front fog lights will switch headlamps on automatically.

Parking Lamps

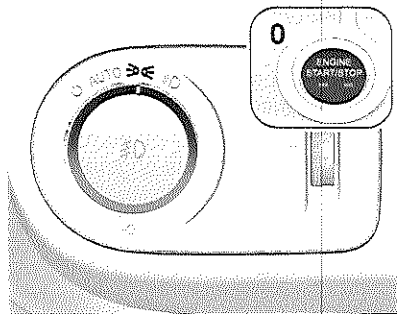

When ignition is switched off the parking lamps can be activated by turning the exterior lamp control to position **P**.

When opening the door, a chime will remind the driver that parking lamps are activated.

Reversing Lamps

The back-up lamp illuminates when the ignition is on and reverse gear is selected.

Misted Lamp Covers

The inside of the bulb housing may fog up briefly in poor, wet, and cold-weather conditions, or in heavy rain or after washing. The fog disappears quickly by itself, but to speed it up, switch on the headlamps.

Interior Lighting

Instrument Panel Illumination Control

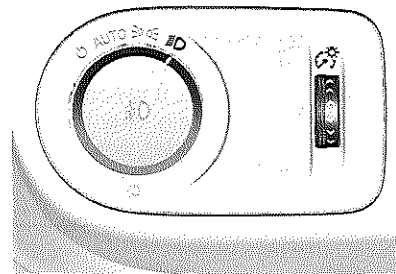

Brightness of the following lights can be adjusted when the headlamps are on:

- Instrument panel illumination
- Steering wheel controls
- Information Display
- Infotainment system operation elements

- Climate control operation elements
- Illuminated switches

Turn knob  and hold until the desired brightness is achieved.

Night Panel

To improve night driving conditions inside the car, select **Night Panel** mode by pressing the **Night Panel** button.

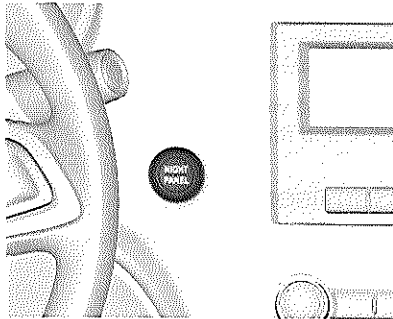

In this mode, the amount of information displayed is reduced, and only the most important instruments and displays will be illuminated. When the **Night Panel** button is pressed, all

gauges and indicators are set to zero. The speedometer remains lit. Backlighting is dimmed. The lighting in the Driver Information Center and Information Display also turns off.

Note

All indicators, warnings, and CHECK messages continue to function as usual except for **Ice warning**.

The following conditions will wake up the respective displays in **Night Panel** mode:

- If Infotainment system or Driver Information Center (DIC) is set, the display comes on for 10 seconds.
- If a warning message is indicated in the DIC.
- If the engine runs at high revs, the tachometer will be illuminated until the engine speed drops again.
- If the quantity of fuel remaining falls below 15 liters, the fuel gauge will be illuminated.
- If the engine temperature rises above normal, the temperature gauge will be illuminated.

- If the gear shift lever on automatic transmission models is moved from position D to position M, the selector indication on the automatic transmission display will be illuminated.

To restore the displays and lighting to normal mode, press the **Night Panel** button.

Interior Lamps

When entering and exiting the vehicle, the front and rear courtesy lamps automatically switch on and then off after a delay.

Notice

In the event of an accident with air-bag deployment the courtesy lights are turned on automatically.

Front Courtesy Lamp

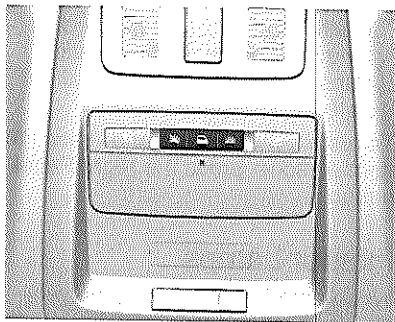

Operate rocker switch:

 = automatic switching on and off.

press  = on.

press  = off.

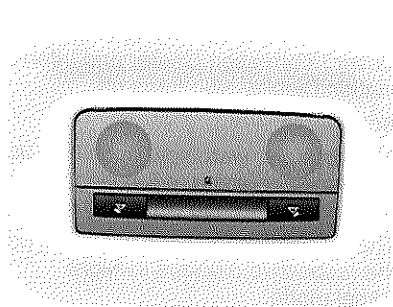

Rear Courtesy Lamps

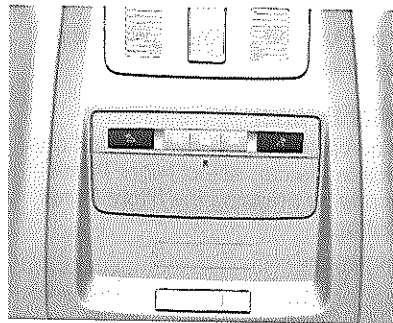

Illuminate in conjunction with the front courtesy lamp, depending on rocker switch position.

Reading Lamps



Operated with  and  buttons in front and rear courtesy lamps.

Sunvisor Lamps

Illuminates when the cover is opened.

Lighting Features

Entry Lighting

Locating the Vehicle Function

Locate the vehicle by pressing the  button on the remote control once. This will activate the turn signals and horn three times.

This makes it easier to locate the vehicle.

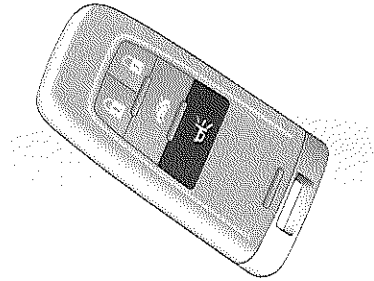

Press  again or switch on ignition to deactivate this function.

Press and hold  button for at least three seconds to activate the panic alarm, [⇨ 18](#).

Welcome lighting

Headlamps, taillamps, back-up lamps, license plate lights, interior lamps, and puddle lights are switched on for a short time when the vehicle is unlocked with the  button on the remote control if the exterior lamp control is in **AUTO** and the light sensor detects that it is nighttime.

The lighting switches off immediately when the ignition is switched on or when  is pressed again.

This function can be activated and deactivated in the Settings menu in the Driver Information Display. Vehicle personalization [⇨ 114](#).

The settings currently set for the remote control can be saved [⇨ 18](#).

Exit Lighting

The following lights switch on if the ignition is switched off, the exterior lamp control is in **AUTO**, the driver's door is opened, and lighting conditions outside are poor:

- Headlamps
- Taillamps
- Back-up lamps
- License plate lamps
- Interior lamps
- Puddle lights

They will switch off automatically after a delay. Theater lighting is activated if the driver's door is opened during this time.

Activation, deactivation, and duration of this function can be changed in the settings menu of the Graphic Information Display or the vehicle menu in the Color Information Display. Vehicle personalization [⇨ 114](#).

Theater lighting

A softlight illumination is incorporated into the interior lighting and in the interior door handles. It comes on when the headlamps are switched on. Depending on the version, softlights are also incorporated in the front footwell and in the door pockets.

Battery Power Protection

Battery State of Charge Function

This function guarantees longest battery life via a generator with controllable power output and optimized power distribution.

To prevent discharge of the battery when driving, the following systems are reduced automatically in two stages and finally switched off:

- Heated rear window and mirrors
- Heated seats
- Fan

In the second stage, a message will be displayed in the Driver Information Center confirming the activation of the battery discharge protection.

Switching Off Electric Lights

To prevent discharge of the battery when the ignition is switched off, some interior lamps are switched off automatically after a period of time.

Climate Control

Climate Control Systems 133
 Air Vents 140
 Maintenance 141

Climate Control Systems

Electronic Climate Control System

Heating, cooling, and ventilation of the vehicle can be controlled by the system.

Dual Zone Automatic Climate Control System

The dual zone climate control allows different climate control temperatures for the driver and front passenger sides.

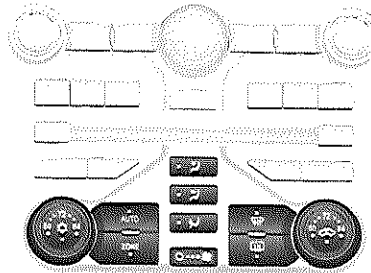

Controls:

- Lo = driver's side temperature setting
- 60..72..82
- Hi = air conditioning on/off
- ☼
- AUTO = automatic mode on
- ZONE = separate climate zone setting
- ↺ ↻ ↷ = air distribution setting
- ...% = fan speed setting
- ☼ = defogging and defrosting on/off
- ☼ = heated rear window on/off ↻ 32.
- 🚗 = manual air recirculation on/off
- Lo = passenger's side temperature setting
- 60..72..82
- Hi

The preselected temperature is automatically regulated. In automatic mode, the fan speed and air distribution automatically regulate air flow.

In automatic mode, the LED in the button is illuminated. The system can be manually adjusted using the air

distribution and air flow controls, as well as A/C button and manual air recirculation button.

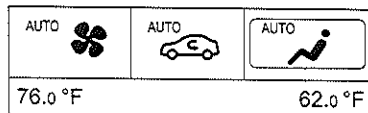

Each change of settings, except heated rear window, is shown in the Driver Information Display for a few seconds.

Climate control system settings can be changed in the **Settings** menu in the Graphic Information Display or **Vehicle** in the Color Information Display.

Vehicle personalization ⇨ 114.

The electronic climate control system is only fully operational when the engine is running.

Automatic Mode AUTO

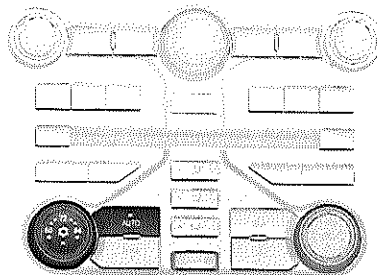

Basic setting for maximum comfort:

- Pressing the **AUTO** button automatically activates the climate control system, indicated by the LED in the button.
- Open all air vents.

- Set the preselected temperatures for driver and front/rear passenger by turning the knob right or left.
- The most common temperature setting is between 68 and 76° F, depending on personal preference.

The fan speed regulation in automatic mode can be changed in the **Settings** menu in the Graphic Information Display or **Vehicle** in the Color Information Display.

Vehicle personalization ⇨ 114.

All air vents are actuated automatically in automatic mode. The air vents should therefore always be open.

Temperature Preselection

In dual zone mode, the temperature can be adjusted separately for the driver and front/rear passengers. Turn the temperature knob left or right to adjust temperature on the corresponding side. The rear seat temperature is the same as the front passenger setting. Set each side between 60° F and 82° F.

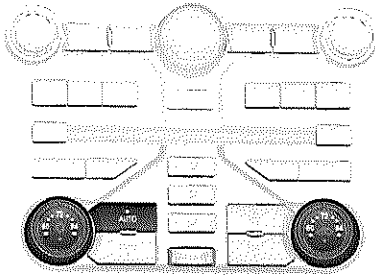

Zone Selection ZONE

One or two respective three climate zones can be selected.

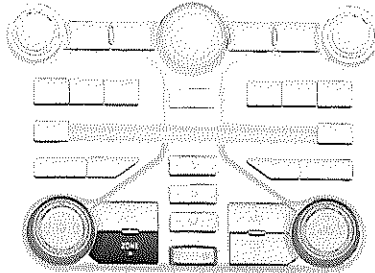



Press the **ZONE** button to link all climate zone settings to the driver's settings. The LED in the **ZONE** button and on the passenger's temperature knob are off. A pop-up message will show in the Driver Information Display. The temperature is set according to the temperature knob for the driver's side.

To go back to multiple temperature zones, adjust the passenger temperature knobs. The LEDs in the **ZONE** button and on the passenger's temperature knob will illuminate.

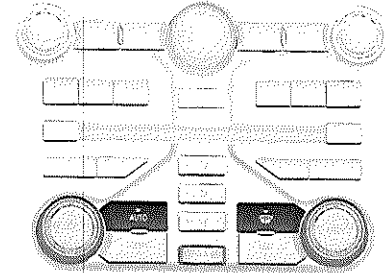
Defogging and Defrosting the Windows



- Press the  button.
- Temperature and air distribution are set automatically, and the fan will run at high speed.
- Switch on heated rear window .
- To switch off defogging and defrosting mode and return to automatic mode, press the **AUTO** button. Press the  button to return to the previously selected manual mode.



Heated Rear Window

Operation ⇨ 32.

Manual Settings

Climate control system settings can be changed by activating the buttons as follows. Changing a setting will deactivate automatic mode.

Fan Speed

Press  on the rocker switch to increase fan speed or  to decrease. The fan speed is indicated by the number of lit LEDs above the rocker switch.

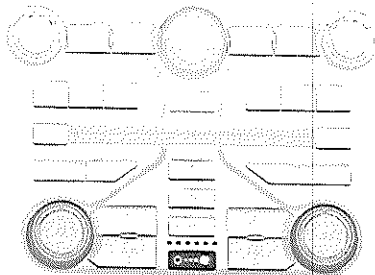



If you press  longer or multiple times, the fan and cooling are switched off, and the air conditioning system is also deactivated.

If you press  longer or multiple times, the fan will run at maximum speed.

To return to automatic mode: Press the **AUTO** button.

Air Distribution

Press the , , or  button for the desired adjustment. Activation is indicated by the LED in the button.

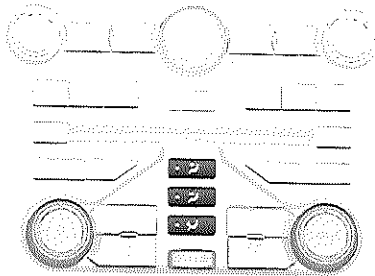

 = to windshield and front door windows.

 = to head area via adjustable air vents

 = to footwell.

Combinations are possible.

Return to automatic air distribution: Deactivate corresponding setting or press **AUTO** button.

Air Conditioning

Activate or deactivate with the  button. Activation is indicated by the LED in the button.

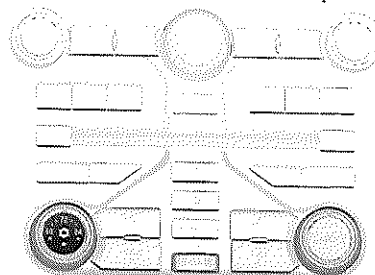

The air conditioning system cools and dehumidifies (dries) the air when the outside temperature is above freezing. Therefore, condensation may form and drip under the vehicle.

Manual Air Recirculation Mode

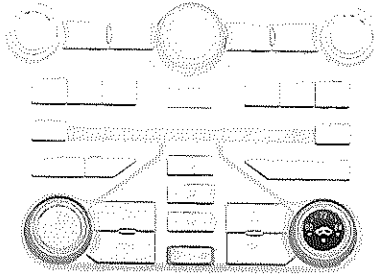

Press the  button to activate recirculation. Activation is indicated by the LED in the button.

Activated: Inside air is recirculated to prevent outside air and odors from entering.

Deactivated: Outside air is circulated through the vehicle.

Warning

The exchange of fresh air is reduced in air recirculation mode. During operation without cooling, air humidity increases so the windows may fog up. The quality of the passenger compartment air deteriorates, which may cause the vehicle occupants to feel drowsy.

Automatic air recirculation

The climate control system has a sensor that detects air pollution. When the system is in the automatic mode **AUTO** (LED is on), the system switches automatically to inside recirculated air when air pollution is detected.

You can change the sensitivity or deactivate this function in the **Settings** menu in the Graphic Information Display or **Vehicle** in the Color Information Display. Vehicle personalization  114.

Automatic Defog

The system has a sensor that detects high humidity inside the vehicle. If inside air humidity is too high, the system switches automatically to outside air. Switch on air conditioner , change the air distribution mode, and increase fan speed and temperature. If humidity drops, the system returns to normal operation.

The automatic defog function can be deactivated in the **Settings** menu in the Graphic Information Display or **Vehicle** in the Color Information Display.

Vehicle personalization  114.

Automatic Rear Window Defogger

The rear window defogger can be set to automatic operation when the interior temperature is cold and the outside temperature is below 39° F.

The rear window defogger switches off automatically after about 10 minutes.

The automatic rear window defog function can be activated or deactivated in the **Settings** menu in the Graphic Information Display or **Vehicle** menu in the Color Information Display. Vehicle personalization ⇨ 114.

Basic Settings

Some settings can be changed in the **Settings** menu in the Graphic Information Display or **Vehicle** menu in the Color Information Display. Vehicle personalization ⇨ 114.

Solar Sensor

The climate control system uses the sensor information to adjust temperature, fan speed, recirculation, and air distribution for best comfort.

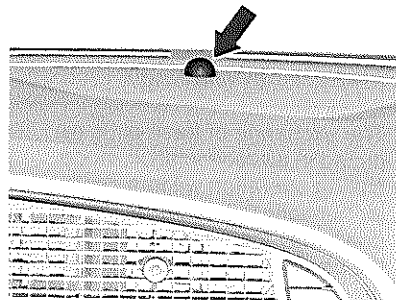

The sensor is located on top of the instrument panel behind the windshield. If the sensor is covered, the climate control system may not work properly.

Rear Air Conditioning System

The rear air conditioning system makes it possible to have nearly independent climate control for the rear seats by adjusting the setting for temperature, air distribution, and fan speed.

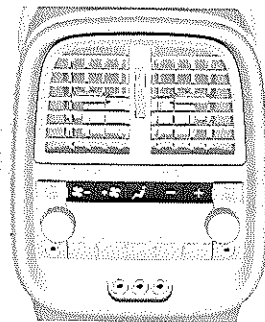

Controls

- ✖ - or + = fan speed setting
- ✖ = air distribution setting / automatic mode
- ~ = rear passenger temperature setting

The preselected temperature is automatically regulated. In automatic mode, the fan speed and air distribution automatically regulate air flow.

The system can be manually adjusted using the air distribution and air flow controls.



Each change of settings is indicated in the rear climate control display. If rear audio is on, the settings disappear after a few seconds.

Switching Rear Climate Control System On or Off

Switch on by pressing any rear climate control button.

When rear climate control is switched on from the rear, the LED in the **ZONE** button in the front panel illuminates.

Press the **ZONE** button to switch off the rear blower and match the rear settings to the front settings. The LED in the **ZONE** button and the rear climate control display will turn off.

Switch off rear climate control by pressing the **✖** button. There is no air flow from the rear vents or rear floor.

Rear climate control will not work if the front climate control is in defrost mode.

Automatic Mode for Rear Climate Control System

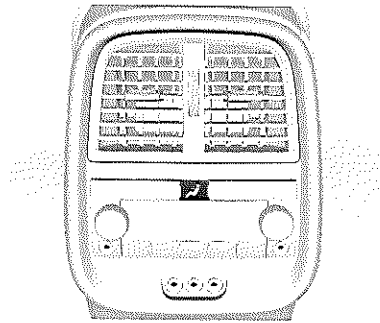

- Press the  button until **AUTO** is indicated on the display.
- Open the rear air vents.
- Set the preselected temperature by pressing the **+** or **-** buttons.

Air is only cooled if the  button in the front climate control panel is activated. Activation is indicated by the LED in the button.

Manual Settings





Rear climate control system settings can be changed by activating the buttons as follows. Changing a setting will deactivate automatic mode.



Fan Speed

Press the **✖** button to decrease fan speed or **+ ✖** to increase. The fan speed is indicated on the display.

To return to automatic mode, press the  button until **AUTO** is indicated on the display.

Air Distribution

Press the  button until the desired adjustment,  or  or , appears. The mode is indicated on the display.

-  = to head area via adjustable air vents
-  = air to footwell and rear fan will be shut off
-  = to head area and footwell balanced

To return to automatic mode, press the  button until **AUTO** is indicated on the display.

Temperature Preselection + -

The temperature can be adjusted separately for the rear passengers. Press the **+** button for warmer air or **-** for cooler air. The value is indicated on the display.

Air Vents

Adjustable Air Vents

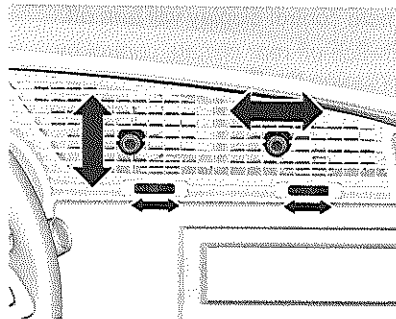

Turn the adjuster wheel to open or close the vent or to adjust the air flow.

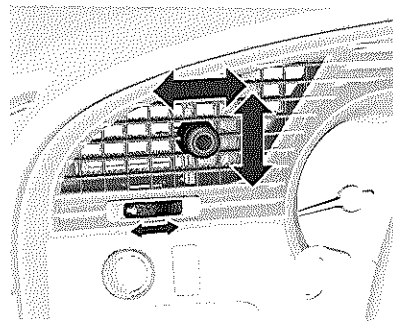

Direct the flow of air by tilting and swiveling the louvers.

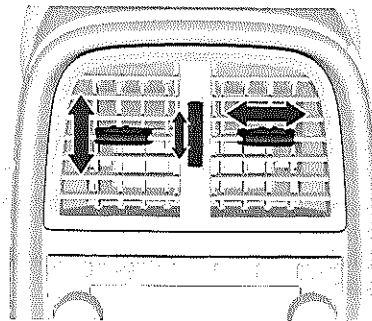

Warning

Do not attach any objects to the slats of the air vents. Risk of damage and injury in case of an accident.

Fixed Air Vents

Additional air vents are located beneath the windshield and door windows and in the front and rear footwells.

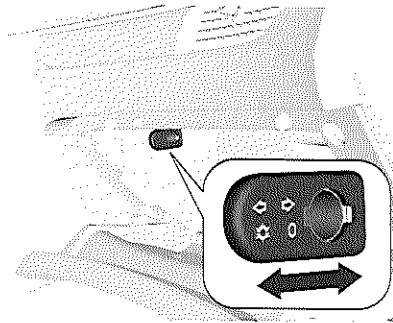
Glove Box Cooler

Cooled air is distributed into the glove box through a vent.

If glove box cooling is not required, slide the vent closed.

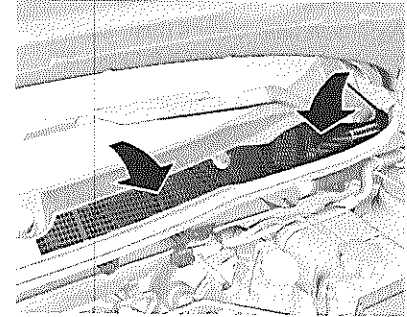
Maintenance**Air Intake**

The air intake to the engine compartment located in front of the windshield must be kept clear to allow for air intake. Remove any leaves, dirt, or snow.

Passenger Compartment Air Filter

Cabin Air Filtration

A particle filter cleans dust, soot, pollen, and spores from the cabin air.

Active Carbon Filter

In addition to the particle filter, the active carbon filter reduces odors.

Filter service must be performed during regular service intervals.

Air Conditioning Regular Operation

In order to ensure continuous efficient performance, the air conditioning must be run for a few minutes each month, regardless of the weather and time of year. The vehicle cannot be operated with the air conditioning on when the outside temperature is too low.

General hints

Clear away any ice, snow, or leaves from the air intake at the base of the windshield; these could block the flow of air into the vehicle.

Keep the path under the front seats free of objects to help circulate the air inside the vehicle more effectively.

Keep all vents open whenever possible for best system performance.

Use of non-Saab approved hood deflectors can adversely affect the performance of the system.

Service

For optimal cooling performance, it is recommended you check the climate control system each year, starting three years after initial vehicle registration, including:

- Functionality and pressure test
- Heating functionality
- Leakage check
- Check of drive belts

- Clean condenser and evaporator drainage
- Performance check

Driving and Operating

Driving Information	143
Starting and Operating	143
Engine Exhaust	146
Automatic Transmission	146
Drive Systems	150
Brakes	150
Ride Control Systems	153
Cruise Control	156
Object Detection Systems	157
Fuel	160
Towing	164

Driving Information

Control of a Vehicle

Never coast with engine not running

Many systems will not function in this situation (e.g. brake servo unit, power steering). Driving in this manner is a danger to yourself and others.

Pedals

To ensure the pedal travel is uninhibited, there must be no mats in the area of the pedals.

Warning

Additional mats must always be thoroughly secured to the floor, otherwise they could slide forward. This is particularly important on the driver's side as the mat could otherwise slide under the pedals and interfere with driving. Never use additional mats on top of each other.

Starting and Operating

New Vehicle Break-In

Do not brake unnecessarily hard for the first few journeys.

During the first drive, smoke may occur because of wax and oil evaporating off the exhaust system. Park the vehicle in the open for a while after the first drive and avoid inhaling the fumes.

During the running-in period fuel and engine oil consumption may be higher.

Starting the Engine

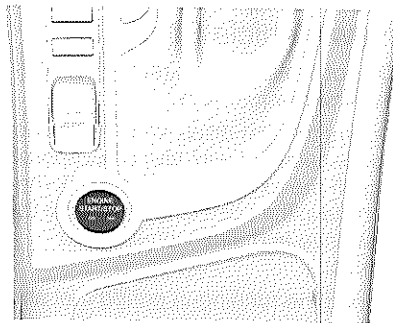

- The remote control unit needs to be in the passenger compartment.
- Press and hold brake pedal and move selector lever in **P** or **N**.
- Push **Start/Stop** button to start the engine.
- Do not press accelerator pedal while starting.

Switching off the engine

- Push **Start/Stop** button while engine is running and vehicle stationary to switch off the engine.

- In case of emergency the engine can be switched off while the vehicle is running: push **Start/Stop** button twice. When the engine is not running, considerably more force is needed to brake and steer.

Accessory power mode

Push **Start/Stop** button once without pressing brake pedal: **accessory power mode** is active, the yellow LED in the button illuminates. In this mode some electrical functions are operable.

Ignition on power mode

Push and hold **Start/Stop** button for 3 to 5 seconds without pressing brake pedal: **Ignition on power mode** is active, the green LED in the button illuminates. In this mode all electrical functions are operable.

To start the engine from **Ignition on power mode**, press brake pedal and push **Start/Stop** button once more.

Notice

Do not put the remote control in the luggage compartment or very close to the Info-Display.

Emergency operation

If either the remote control fails or the battery of the remote control is weak, unlock (1) the driver's door with the mechanical key ↻ 18. The Driver Information Center may display **No Remote Detected** or **Replace Battery in Remote Key** when you try to start the vehicle.

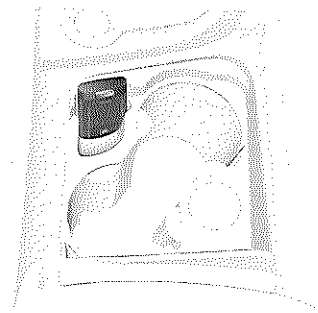

Open the center console storage area. Place the Remote Control in the transmitter pocket near the cupholder. Depress the brake pedal and push the **Start/Stop** button.

To switch off the engine, push the **Start/Stop** button again. Remove the remote control of the transmitter pocket and push inside locking knob of all doors except driver's door. Then close the driver's door and lock it from the outside with the mechanical key (2).

Fault in remote control system or passive entry system ⇨ 20.

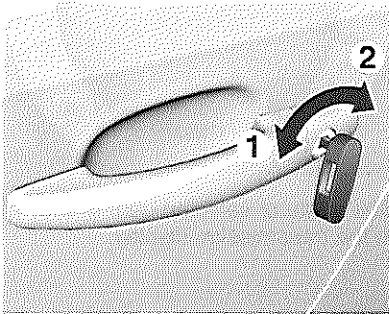

This option is intended for emergencies only. Replace the remote control battery as soon as possible ⇨ 18.

Parking

- Do not park the vehicle on an easily ignitable surface. The high temperature of the exhaust system could ignite the surface.
- Always apply the electric parking brake.
- If the vehicle is on a level surface or uphill slope, set the gear shift lever to **P** before switching off the engine. On an uphill slope, turn the front wheels away from the curb.
- If the vehicle is on a downhill slope, set the gear shift lever to **P** before switching off the engine. Turn the front wheels toward the curb.
- Lock the vehicle and activate the anti-theft alarm system.

Notice

In the event of an accident with air-bag deployment the engine is turned off automatically, if the vehicle is coming to a stillstand within a certain time.

Engine Exhaust

⚠ Danger

Engine exhaust gases contain poisonous carbon monoxide, which is colorless and odorless and could be fatal if inhaled.

Open the windows if exhaust gases penetrate the vehicle interior. Have the cause of the fault remedied by a workshop.

Avoid driving with an open tailgate. Otherwise, exhaust gases could enter the vehicle.

Catalytic Converter

The catalytic converter reduces the amount of harmful substances in the exhaust gases.

Caution

Fuel grades other than those listed on page ⇨ 160 could damage the catalytic converter or electronic components.

Unburnt petrol will overheat and damage the catalytic converter. Therefore avoid excessive use of the starter, running the fuel tank dry and starting the engine by pushing or towing.

In the event of misfiring, uneven engine running, a reduction in engine performance or other unusual problems, have the cause of the fault rectified by a workshop as soon as possible. In an emergency, driving can be continued for a short period, keeping vehicle speed and engine speed low.

Automatic Transmission

The automatic transmission permits automatic gearshifting (automatic mode) or manual gearshifting (manual mode).

Transmission display

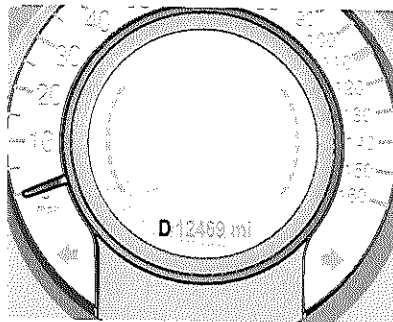

The mode or selected gear is shown in the transmission display.

Selector lever

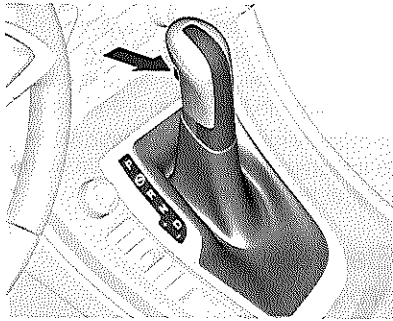

- P** = park position, wheels are locked, engage only when the vehicle is stationary and the parking brake is applied
- R** = reverse gear, engage only when vehicle is stationary
- N** = neutral
- D** = automatic mode with all gears

The selector lever is locked in **P** and can only be moved when ignition mode is on, the brake pedal is applied and the release button on the selector lever is pressed.

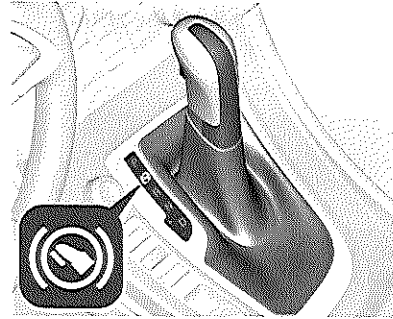

Without applied brake pedal the control indicator  illuminates.

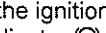
If the selector lever is not in **P** when the ignition is switched off, control indicator  and **P** flash.

To engage **P** or **R**, push the release button.

The engine can only be started with lever in position **P** or **N**. When position **N** is selected, press brake pedal.

Do not accelerate while engaging a gear. Never depress the accelerator pedal and brake pedal at the same time.

When a gear is engaged, the vehicle slowly begins to creep when the brake is released.

Engine braking

To utilize the engine braking effect, select a lower gear in good time when driving downhill, see manual mode.

Rocking the vehicle

Rocking the vehicle is only permissible if the vehicle is stuck in sand, mud or snow. Move the selector lever between **D** and **R** in a repeat pattern. Do not race the engine and avoid sudden acceleration.

Parking

Apply the parking brake and engage **P**.

Manual Mode

Manual mode with selector lever

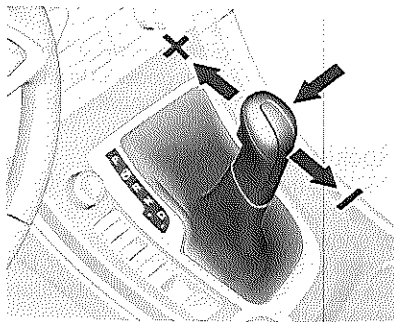

Move selector lever out of position **D** towards the left and then forwards or backwards.

M or the number of the selected gear is indicated in the transmission display.

- + = Shift to a higher gear.
- = Shift to a lower gear.

Manual mode with steering wheel shifter

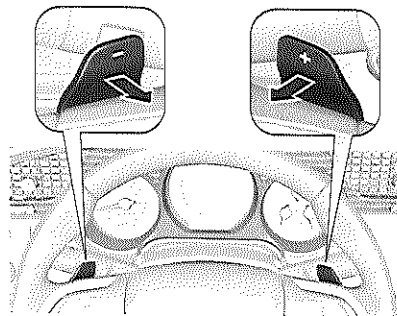

Move selector lever out of position **D** towards the left.

M or the number of the selected gear is indicated in the transmission display.

Use steering wheel shifter to select gears manually.

- + = right shifter, pull for high shifting.
- = left shifter, pull for low shifting.

General

If a higher gear is selected when vehicle speed is too low, or a lower gear when vehicle speed is too high, the shift is not executed. This can cause a message in the Driver-Info-Display.

In manual mode no automatic shifting to a higher gear takes place at high engine revolutions.

Electronic Driving programs

- Following a cold start, the operating temperature program increases engine speed to bring the catalytic converter to the required temperature quickly.
- The automatic neutral shift function automatically shifts to idle when the vehicle is stopped with a forward gear engaged and the brake pedal is pressed. This function is not available on all engines.
- When Sport mode is engaged, the vehicle shifts at higher engine speeds (unless cruise control is on); some additional functionalities,

such as holding gears during accelerator pedal release and early downshift when braking, are enabled. Sport mode ⇨ 154.

- Special programs automatically adapt the shift points when driving up inclines or down hills.

Kickdown

If the accelerator pedal is pressed down completely when driving in Automatic mode, the transmission shifts to a lower gear depending on engine speed.

Fault

In the event of a fault,  together with a vehicle message is displayed in the Driver Information Center. Vehicle messages ⇨ 111.

The transmission no longer shifts automatically. Continued travel is possible with manual shifting.

Only the highest gear is available. Depending on the fault, 2nd gear may also be available in manual mode. Shift only when vehicle is in standstill.

Have the cause of the fault remedied by a workshop.

Interruption of Power Supply

In the event of an interruption of power supply, the selector lever cannot be moved out of the P position.

If the battery is discharged, start the vehicle using jump leads ⇨ 216.

If the battery is not the cause of the fault, release the selector lever.

Release selector lever

1. Apply parking brake.

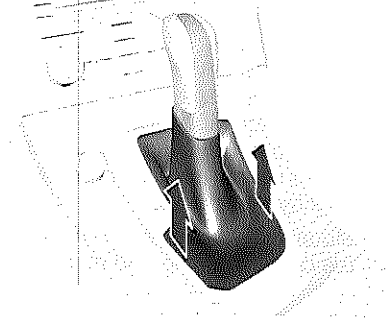

2. Release selector lever trim from center console at rear, fold upwards and rotate to the left.

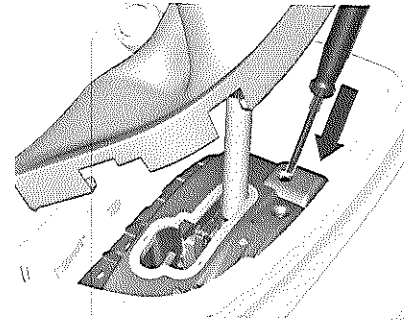

3. Insert a screwdriver into the opening as far as it will go and move the selector lever out of **P** or **N**. If **P** or **N** is engaged again, the selector lever will be locked in position again. Have the cause of the power supply interruption remedied by a workshop.
4. Mount the selector lever trim on the center console and refit.

Drive Systems

Cross-wheel drive

The Cross-wheel drive system enhances driving characteristics and stability, and helps to achieve the best possible driveability regardless of ground surface. The system is always active and cannot be deactivated.

The torque is distributed steplessly between the front and rear wheels, depending on the driving conditions.

For optimum system performance, the vehicle's tires should not have varying degrees of wear.

If a message regarding Cross-wheel drive is displayed in the Driver Information Center, the system may have limited functionality (or be completely disabled in some cases, i.e. the vehicle switches to Front-wheel drive).

Seek the assistance of a workshop if following messages are displayed:

- Service All Wheel Drive System
- Service Rear Axle

Towing the vehicle ⇨ 218.

Brakes

The brake system consists of two independent brake circuits.

If a brake circuit fails, the vehicle can still be braked using the other brake circuit. However, braking effect is achieved only when the brake pedal is depressed firmly. Considerably more force is needed for this. The braking distance is extended. Seek the assistance of a repair shop before continuing travel.

When the engine is not running, assistance from the brake servo unit disappears once the brake pedal has been depressed once or twice. Braking effect is not reduced, but braking requires significantly greater force. It is especially important to keep this in mind when being towed.

Control indicator (C) ⇨ 100.

Antilock Brake System (ABS)

Antilock brake system (ABS) prevents the wheels from locking.

ABS starts to regulate brake pressure as soon as a wheel shows a tendency to lock. The vehicle remains steerable, even during hard braking.

ABS control is made apparent through a pulse in the brake pedal and the noise of the regulation process.

For optimum braking, keep the brake pedal fully depressed throughout the braking process, despite the fact that the pedal is pulsating. Do not reduce the pressure on the pedal.

Control indicator  100.

Adaptive brake light and hazard warning flashers

During full ABS braking, all three brake lights flash for the duration of ABS control.

Fault

Warning

If there is a fault in ABS, the wheels may be liable to lock due to braking that is heavier than normal. The benefits of ABS are no longer available. During hard braking, the vehicle can no longer be steered and may swerve.



Have the cause of the fault remedied by a workshop.

Parking Brake

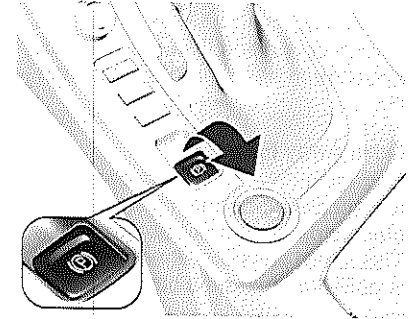
Electric Parking Brake



Applying When Vehicle Is Stationary

Pull switch ; the electric parking brake operates automatically with an adequate force. For maximum force, e.g. parking with trailer or on inclines, pull switch  twice.

The electric parking brake can always be activated, even if the ignition is off.

Do not operate the electric parking brake system too often when the engine is not running; this will discharge the battery.

Before leaving the vehicle, check the electric parking brake status.

Control indicator  ⇨ 100.

Releasing

Switch on ignition. Keep brake foot pedal depressed, then push switch .

Drive Away Function

Engaging drive gear then depressing the accelerator pedal releases the electric parking brake automatically. This is not possible when the switch is pulled at the same time.

This function also helps when driving away on inclines.

Aggressive drive away may reduce lifetime of wearing parts.

Dynamic Braking When Vehicle Is Moving



When the vehicle is moving and the switch  is kept pulled, the electric parking brake system will decelerate the vehicle using the ESP system. The parking brake will not apply statically.



As soon as the switch  is released, dynamic braking will be stopped.

Do not use this feature for everyday breaking, as it may reduce the life of the ESP pump unit.

Fault

Fault mode of electric parking brake is indicated by a control indicator  and a vehicle message in the Driver Information Center. Vehicle messages ⇨ 111.

Apply electric parking brake: pull and hold the switch  for more than 5 seconds. If control indicator  illuminates, electric parking brake is applied.

Release electric parking brake: push and hold the switch  for more than 2 seconds. If control indicator  turns off, electric parking brake is released.

Control indicator  flashes: electric parking brake is not fully applied or released. When continuously flashing, release electric parking brake and apply again.

 flashes 2 times when parking brake is applied.

Brake Assist

If the brake pedal is depressed quickly and forcefully, maximum brake force is automatically applied (full braking).

Maintain steady pressure on the brake pedal for as long as full braking is required. Maximum brake force is automatically reduced when the brake pedal is released.

Ride Control Systems

Traction Control System (TCS)

Traction Control System (TCS) improves driving stability when necessary, regardless of the type of road surface or tire grip, by preventing the drive wheels from spinning.

As soon as the drive wheels starts to spin, engine output is reduced and the wheel spinning the most is braked individually. This considerably improves the driving stability of the vehicle on slippery road surfaces.

TCS is operational as soon as the control indicator  extinguishes.

When TCS is active  flashes.

Warning

Do not let this special safety feature tempt you into taking risks when driving.

Adapt speed to the road conditions.

Control indicator  \Rightarrow 101.

Deactivation

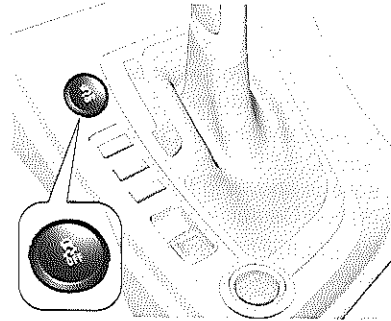

TCS can be switched off when spinning of drive wheels is required: press button  shortly.

Control indicator  illuminates and a message is indicated in the Driver Information Center.

TCS is reactivated by pressing the  button again.

TCS is also reactivated the next time the ignition is switched on.

Electronic Stability Program

The Electronic Stability Program (ESP) improves driving stability when necessary, regardless of the type of road surface or tire grip. It also prevents the drive wheels from spinning.

As soon as the vehicle starts to swerve (understeer/oversteer), engine output is reduced and the wheels are braked individually. This considerably improves the driving stability of the vehicle on slippery road surfaces.

ESP is operational as soon as the control indicator  extinguishes.

When ESP is active,  flashes.

Warning

Do not let this special safety feature tempt you into taking risks when driving.

Adapt speed to the road conditions.

Control indicator  \Rightarrow 101.

Deactivation

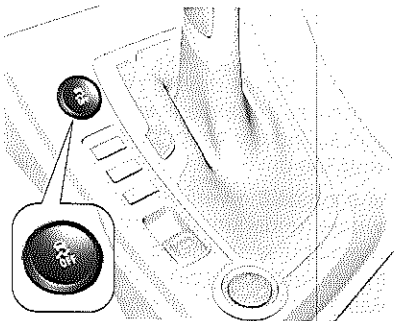

For very high-performance driving ESP can be deactivated: hold button  depressed for approx. 3 seconds.

Control indicator  illuminates and a message is indicated in the Driver Information Center.

ESP is reactivated by pressing the  button again. If the TC system was previously disabled, both TC and ESP are reactivated.

ESP is also reactivated the next time the ignition is switched on.

Interactive Driving System (IDS+)

Drive Sense

The Drive Sense driving system allows the driver to select between three driving modes:

- **COMFORT mode:** turn knob toward **C**; LED illuminates and a message is shown in the Driver Information Center.
- **INTELLIGENT mode:** turn knob toward **I**; LED illuminates.
- **SPORT mode:** turn knob toward **S**; LED illuminates and a message is shown in the Driver Information Center.

With the ignition is switched on, the system starts in Intelligent mode.

COMFORT or SPORT mode Activated is shown by an indicator in the Driver Information Display.

In each driving mode, Drive Sense networks the following electronic systems:

- Continuous Damping Control.
- Accelerator Pedal Control.
- Steering Control.
- Cross-wheel drive control.
- Automatic transmission.

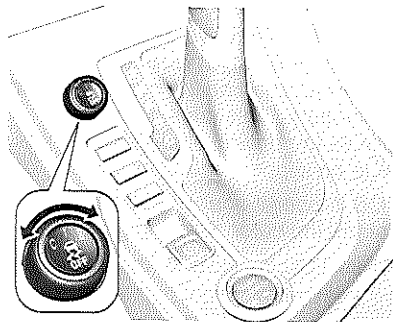

COMFORT Mode

The system settings are adjusted to a comfortable driving style:

- Shock absorbers are less stiff.
- Accelerator pedal reacts with standard settings.

- Steering support is in standard mode.
- An optimal amount of engine torque is distributed to the rear axle to achieve more comfortable vehicle behavior.
- Automatic transmission shift points occur in a comfort mode.

INTELLIGENT Mode

All system settings are adjusted to standard values.

SPORT Mode

System settings are adjusted to a sportier driving style:

- Shock absorbers are stiffer, to provide better contact with the road surface.
- Steering support is reduced.
- An optimal amount of engine torque is distributed to the rear axle to achieve sporty vehicle behavior.
- Automatic transmission shift points occur later.

Drive Mode Control

In INTELLIGENT driving mode, the Drive Mode Control (DMC) detects and continuously analyzes actual driving characteristics, driver responses, and the active dynamic state of the vehicle. If necessary, the DMC control unit automatically changes the settings within the INTELLIGENT driving mode; if it recognizes greater variations, the driving mode is changed to COMFORT or SPORT for the length of variation.

If, for example, INTELLIGENT mode is selected and the DMC detects sporty driving behavior, the DMC changes several settings of the Intelligent mode to sporty settings. The DMC changes to SPORT mode if it detects very sporty driving behavior.

In another example, if INTELLIGENT mode is selected and a sudden hard braking is necessary on a winding road, the DMC will detect the dynamic vehicle condition and change the suspension settings to SPORT mode to increase vehicle stability.

When driving characteristics or the dynamic vehicle state return to former state, the DMC will return the settings to INTELLIGENT driving mode.

Personalized Settings in SPORT Mode

The driver can select the functions of the SPORT mode when **SPORT** setting is selected. These settings can be changed in the **Settings** menu of the Graphic Information Display or **Sport** menu of the Color Information Display. Vehicle personalization ⇨ 114.

Cruise Control

The cruise control can store and maintain speeds of approx. 20 to 120 mph. Deviations from the stored speeds may occur when driving uphill or downhill.

For safety reasons, the cruise control cannot be activated until the foot brake has been operated once. It cannot be activated in first gear.

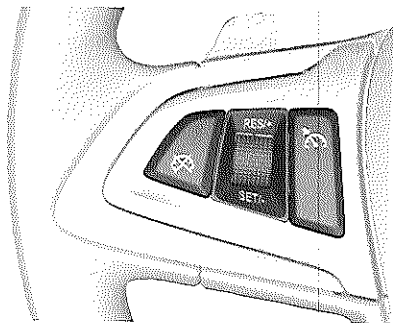



Do not use cruise control if it is not advisable to maintain a constant speed.

With automatic transmission, only activate cruise control in automatic mode.

Control indicator  102.

Switching On

Press the upper end of the  rocker switch; the control indicator  illuminates white.

Activation

Accelerate to the desired speed and turn the thumb wheel to **SET/-**; the current speed is stored and maintained. Control indicator  illuminates green. The stored speed is displayed as a pop-up message **Cruise Set To ...** in the Driver Information Center. The accelerator pedal can be released.

Vehicle speed can be increased by depressing the accelerator pedal. When the accelerator pedal is released, the previously stored speed is resumed.

Increase Speed



With cruise control active, hold thumb wheel turned to **RES/+** or briefly turn to **RES/+** repeatedly: speed increases continuously or in small increments.

Alternatively, accelerate to the desired speed and store by turning to **SET/-**.

Reduce Speed

With cruise control active, hold thumb wheel turned to **SET/-** or briefly turn to **SET/-** repeatedly: speed decreases continuously or in small increments.

Deactivation

Press  button; control indicator  illuminates white. Cruise control is deactivated. The stored speed is maintained.

Automatic Deactivation:



- vehicle speed below approx. 20 mph,
- the brake pedal is depressed,
- gear shift lever in **N**,

- the electric parking brake is applied,
- the Traction Control System or Electronic Stability Control is operating.

Resume Stored Speed

Turn thumb wheel to RES/+ at a speed above 20 mph. The vehicle will accelerate to the stored speed.

Switching Off

Press the lower end of the  rocker switch; control indicator  is off. The stored speed is deleted. Switching off the ignition also deletes the stored speed.

Object Detection Systems

Parking Assist

Parking assist system

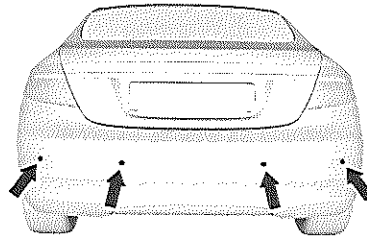

The parking assist system makes parking easier by measuring the distance between the vehicle and obstacles, and giving acoustic signals. It is the driver, however, who bears full responsibility for the parking manoeuvre.

The system consists of four ultrasonic parking sensors in each of the front and rear bumpers.

Activation

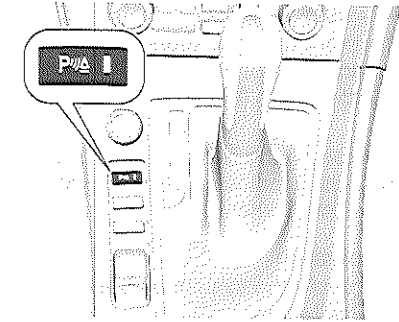

When reverse gear is engaged, the system is activated automatically.

The front parking assist can also be activated at a low speed by pressing the  button.

An illuminated LED in the parking assist button indicates that the system is ready to operate.

An obstacle is indicated by a buzzing sound. The interval between the sounds becomes shorter as the vehicle gets closer to the obstacle. When the distance is less than one ft., the buzzing is continuous.

There are different sounds for the indication of front and rear obstacles, sounding from front and rear speakers.

Additionally the front distance to an obstacle is indicated in the Driver Information Center.

Deactivation

Deactivate the system by pressing the **P** button.

The LED in the button will go out and **Park Assist Off** will be displayed in the Driver Information Center.

The system is deactivated automatically when the vehicle is driven above a certain speed.

Fault

In the event of a fault in the system, a message is displayed in the Driver Information Center.

If the system does not work due to temporary conditions like snow covered sensors, a message is displayed in the Driver Information Center.

Vehicle messages ⇨ 111.

Important hints for using the parking assist systems

⚠ Warning

Under certain circumstances, various reflective surfaces on objects or clothing as well as external noise sources may cause the system to fail to detect obstacles.

Caution

Performance of the sensor can be reduced when sensors are covered, e.g. by ice or snow.

Performance of the parking assist systems can be reduced by a level change of the sensors due to heavy loading.

Special conditions apply if there are taller vehicles involved (e.g. off-road vehicles, mini vans, vans). Object identification in the upper part of the vehicle cannot be guaranteed.

Objects with a very small reflection cross section, like objects of narrow size or soft materials, may not be detected by the system.

Parking assist systems are not effective in assisting drivers in avoiding a collision with unexpected objects.

Notice

A sensor could detect a non-existing object (echo disturbance) caused by external acoustical or mechanic disturbances.

Lane Departure Warning (LDW)

The Lane Departure Warning system observes the lane markings that the vehicle is driving between via a front camera. The system detects lane changes and warns the driver via visual and acoustic signals in the event of an unintended lane change.

⚠ Warning

It is the driver, however, who always bears full responsibility for the lane change maneuver.

Criteria for the detection of an unintended lane change are



- turn signals not used
- brake pedal not operated

- accelerator not pressed, no acceleration

- no active steering

If the driver is active, no warning will be issued.

Activation

The Lane Departure Warning system is activated by pressing the  button. The illuminated LED in the button indicates that the system is switched on. When the  control indicator in the instrument cluster turns green, the system is ready to operate.

The system is only operable at vehicle speeds above 37 mph and if lane markings are available.

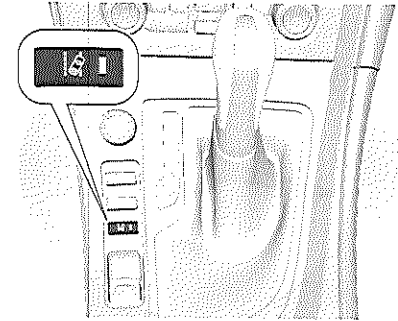

When the system recognizes an unintended lane change, the  control indicator changes to yellow and flashes. A buzzing sound is activated at the same time.

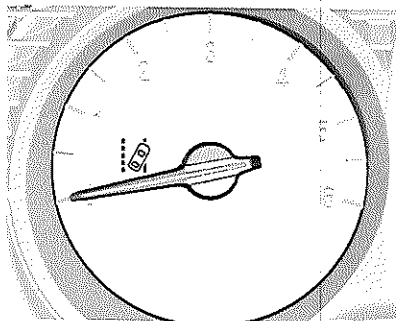

Deactivation

The system is deactivated by pushing the  button. Deactivation is indicated by a message in the Driver Information Center.

At speeds below 37 mph the system is inoperable.

Fault

The Lane Departure Warning system may not operate properly when:

- the windshield is not clean
- there are adverse environmental conditions, such as heavy rain, snow, direct sunlight, or shadows
- no lane marking can be detected

If the Lane Departure Warning system detects one of these conditions, the  control indicator will turn off.

In addition, a warning message will be displayed in the Driver Information Center.

Fuel

Fuel for Petrol Engines

Only use unleaded fuel.

Use of the recommended fuel is an important part of the proper vehicle maintenance.

To help keep the engine clean and maintain optimum vehicle performance, we recommend the use of gasoline advertised as TOP TIER Detergent Gasoline. Look for the TOP TIER label on the fuel pump to ensure gasoline meets enhanced detergency standards developed by auto companies. A list of marketers providing TOP TIER Detergent Gasoline can be found at www.toptiergas.com.

Use fuel with the recommended octane rating  228. Use of fuel with too low an octane rating can reduce engine power and torque and slightly increases fuel consumption.

If the octane is less than 87, you may experience heavy knocking when you drive. If this occurs, use a gasoline rated at 87 octane or higher as soon

as possible. Otherwise, you might damage your engine. A slight pinging noise when you accelerate or drive uphill is considered normal. This does not indicate a problem exists or that a higher octane fuel is necessary. If you are using 87 octane or higher octane fuel and hear heavy knocking, your engine needs service. Although not required, use higher octane (93 octane) fuel for optimum performance.

Caution

Use of fuel with too low an octane rating could lead to uncontrolled combustion and engine damage.

Gasoline Specifications

It is recommended that gasoline meet specifications which were developed by automobile manufacturers around the world and contained in the World-Wide Fuel Charter, which is available from the Alliance of Automobile Manufacturers at www.autoalliance.org/fuel_charter.htm. Gasoline meeting these specifications could provide im-

proved drivability and emission control system performance compared to other gasoline.

At a minimum, gasoline should meet ASTM specification D 4814 in the United States. Some gasoline contains an octane-enhancing additive called methylcyclopentadienyl manganese tricarbonyl (MMT). We recommend against the use of gasoline containing MMT.

Notice

Gasoline containing oxygenates, such as ethers and ethanol, and reformulated gasoline may be available in your area. We recommend that you use this gasoline, if it complies with the specifications described earlier. However, E85 (85% ethanol) and other fuels containing more than 10% ethanol must not be used in vehicles that were not designed for those fuels.

California Fuel

If your vehicle is certified to meet California Emission Standards (see the under-hood emission control label), it is designed to operate on fuels that

meet California specifications. If this fuel is not available in states adopting California emission standards, your vehicle will operate satisfactorily on fuels meeting federal specifications, but emission control system performance may be affected. The fault indicator light may turn on, and your vehicle may fail an emission system inspection ⇨ 99.

If this occurs, return to your authorized Saab dealer for diagnostics. If it is determined that the condition is caused by the type of fuel used, repairs may not be covered by your warranty.

Fuel Additives

To provide cleaner air, every kind of gasoline in the United States is now required to contain additives that help prevent engine and fuel system deposits from forming, allowing the emission control system to work properly. In most cases, you should not have to add anything to the fuel. However, some gasoline contains only the minimum amount of additive required to meet U.S. Environmental

Protection Agency regulations. To help keep fuel injectors and intake valves clean, or if the vehicle experiences problems due to dirty injectors or valves, look for gasoline that is advertised as TOP TIER Detergent Gasoline. Look for the TOP TIER label on the fuel pump to ensure gasoline meets enhanced detergency standards developed by the auto companies. A list of marketers providing TOP TIER Detergent Gasoline can be found at www.toptiergas.com.

Gasoline containing oxygenates, such as ethers and ethanol, and reformulated gasoline might be available in your area. We recommend that you use this gasoline if it complies with the specifications described earlier.

This vehicle was not designed for fuel that contains methanol. Do not use fuel containing methanol. It can corrode metal parts in the fuel system and also damage plastic and rubber parts. This damage is not covered under the vehicle warranty.

Some gasoline that is not reformulated for low emissions may contain an octane-enhancing additive called methylcyclopentadienyl manganese tricarbonyl (MMT); ask the attendant where you buy gasoline whether the fuel contains MMT. Saab does not recommend the use of such gasoline.

Fuels containing MMT can reduce the life of spark plugs, and the performance of the emissions control system may be affected. The fault indicator light may turn on. If this occurs, return to your Saab dealer/retailer for service.

Fuels in Foreign Countries

If you plan on driving in a country outside the United States, the proper fuel might be hard to find. Never use leaded gasoline or any other fuel not recommended in the previous text on fuel. Costly repairs caused by use of improper fuel would not be covered by the vehicle warranty.

To check fuel availability, ask an auto club, or contact a major oil company that does business in the country where you will be driving.

Filling the Tank

Danger

Follow the operating and safety instructions of the filling station when refueling.

If you spill fuel and then something ignites it, you could be badly burned. Fuel can spray out on you if you open the fuel cap too quickly. This spray can happen if your tank is nearly full, and is more likely in hot weather. Open the fuel cap slowly and wait for any "hissing" noise to stop. Then unscrew the cap all the way.

Gasoline fumes are highly explosive. Therefore:

- before refueling, turn off the engine and any external heaters with combustion chambers.
- never smoke while refueling.
- never use gasoline for any purpose other than as engine fuel.

- gasoline is extremely flammable and can cause severe burns. No open or exposed flames near gasoline.
 - do not use a cell phone while refueling.
 - if you can smell fuel in your vehicle, have the cause of this remedied immediately by a workshop.
- If a fire starts while you are refueling, do not remove the nozzle. Shut off the flow of fuel by shutting off the pump or by notifying the station attendant. Leave the area immediately.

Fuel filler flap is located at the right rear side of vehicle.

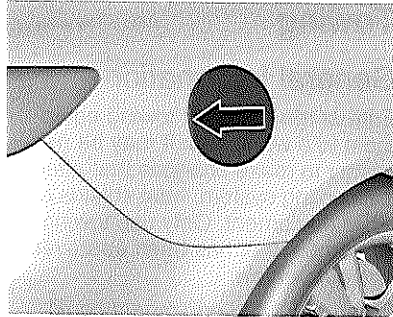

The fuel filler flap can only be opened if the vehicle is unlocked. Release the fuel filler flap by pushing the flap.

To open, turn the cap slowly to the left.

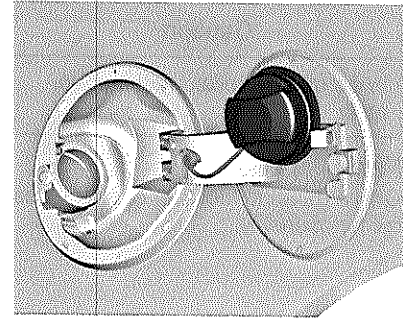

The fuel filler cap can be retained in the bracket on the fuel filler flap.

To close, turn the fuel filler cap to the right until it clicks three times.

Make sure that the cap is fully installed. The diagnostic system can determine if the fuel cap has been left off or is improperly installed. If the fuel cap has been left off or is improperly installed, a warning message is shown on the Driver Information Center.

Caution

Wipe off any spilled fuel immediately.
--

Fuel filler cap

Only a genuine fuel filler cap provides full functionality.

Towing

General Information

Entrust retrofitting of towing equipment to a workshop. It may be necessary to make changes that affect the cooling system, heat shields or other equipment. Only use towing equipment that has been approved for your vehicle.

Fitting of towing equipment could cover the opening of the towing eye. If this is the case use the coupling ball bar for towing.

Driving Characteristics and Towing Tips

Before attaching a trailer, lubricate the hitch ball. However, do not do so if a stabilizer that acts on the hitch ball is being used to reduce snaking movements.

For trailers with low driving stability and trailers with a permitted gross vehicle weight of more than 3086 lbs.

the use of a stabilizer is strongly recommended when driving above 50 mph.

If the trailer starts snaking, drive slower; do not attempt to correct the steering and brake sharply if necessary.

When driving downhill, drive in the same gear as if driving uphill and drive at a similar speed.

Adjust tire pressure to the value specified for full load.

Trailer Towing

Trailer Loads

Permissible trailer loads are maximum values based on your vehicle and engine; they must not be exceeded. The actual trailer load is the difference between the actual gross weight of the trailer and the actual tongue weight with the trailer hitched.

Permissible trailer loads are specified in the vehicle documents. In general, they are valid for inclines of up to max. 12%.

The permitted trailer load applies up to the specified incline and up to an altitude of 3300 ft above sea level. Air becomes thinner as altitude increases, and thus engine power decreases. This reduces climbing ability and also decreases permissible gross trailer weight by 10% for every 3300 ft of additional altitude. Gross trailer weight does not have to be reduced when driving on roads with slight inclines (less than 8%, e.g., highways).

The permissible gross trailer weight must not be exceeded. This weight is specified on the identification plate
◇ 226.

Tongue Weight

The tongue weight is the load exerted by the trailer on the ball hitch. It can be varied by changing the weight distribution when loading the trailer.

The maximum permissible tongue weight (187 lbs.) is specified on the towing equipment identification plate and in the vehicle documents. Always aim for the maximum load, especially

in the case of heavy trailers. The tongue weight should never fall below 55 lbs.

Vehicle Care

General Information	166
Headlight Aiming	167
Vehicle Checks	169
Bulb Replacement	176
Electrical System	182
Vehicle Tools	189
Wheels and Tires	189
Jump Starting	216
Towing	218
Appearance Care	220

General Information

California Proposition 65 Warning

Most motor vehicles, including this one, contain and/or emit chemicals known to the State of California to cause cancer and birth defects or other reproductive harm. Engine exhaust, many parts and systems, many fluids, and some component wear by-products contain and/or emit these chemicals.

California Perchlorate Materials Requirements

Certain types of automotive applications, such as airbag initiators, safety belt pretensioners, and lithium batteries contained in remote keyless transmitters, may contain perchlorate materials. Special handling may be necessary. For additional information, see www.dtsc.ca.gov/hazardous-waste/perchlorate.

Accessories and Modifications

We recommend using Genuine Parts and Accessories and factory approved parts specific for your vehicle type. We cannot assess or guarantee reliability of other products - even if they have a regulatory or otherwise granted approval.

Do not make any modifications to the electrical system, e.g. changes of electronic control units (chip tuning).

Vehicle Storage

Storage for a long period of time
If the vehicle is to be stored for several months:

- Wash and wax the vehicle.
- Have the wax in the engine compartment and underbody checked.
- Clean and preserve rubber seals.
- Change engine oil.
- Drain washer fluid reservoir.

- Check coolant antifreeze and corrosion protection.
- Adjust tire pressure to the value specified for full load.
- Park vehicle in dry, well ventilated place. Engage first or reverse gear or set selector lever to **P**. Prevent the vehicle from rolling.
- Do not apply parking brake.
- Open hood, close all doors and lock the vehicle.
- Disconnect the clamp from the negative terminal of the vehicle battery. Beware that all systems are not functional, e.g. anti-theft alarm system.

Putting back into operation

When the vehicle is to be put back into operation:

- Connect the clamp to the negative terminal of the vehicle battery. Activate the electronics of the power windows.
- Check tire pressure.
- Fill up the washer fluid reservoir.
- Check the engine oil level.

- Check the coolant level.
- Fit the license plate if necessary.

End-of-Life Vehicle Recovery

Information on end-of-life vehicle recovery centers and the recycling of end-of-life vehicles is available on our website. Only entrust this work to an authorized recycling center.

Headlight Aiming

The headlight aiming system has been preset at the factory.

If the vehicle is damaged in an accident, the aim of the headlights may be affected and adjustment may be necessary.

It is recommended that a dealer adjust the headlights. To re-aim the headlights yourself, use the following procedure.

The vehicle should be properly prepared as follows:

- The vehicle should be placed so the headlights are 25 ft. from a light colored wall.
- The vehicle must have all four tires on a level surface which is level all the way to the wall.
- The vehicle should be placed so it is perpendicular to the wall or other flat surface.
- The vehicle should not have any snow, ice, or mud on it.

- The vehicle should be fully assembled and all other work stopped while headlight aiming is being performed.
- The vehicle should be normally loaded with a full tank of fuel and one person or 160 lbs.
- Tires should be properly inflated.

Headlight aiming is done with the vehicle's low-beam headlights. The high-beam headlights will be correctly aimed if the low-beam headlights are aimed properly.

To adjust the vertical aim, do the following:

1. Open the hood ⇨ 170.

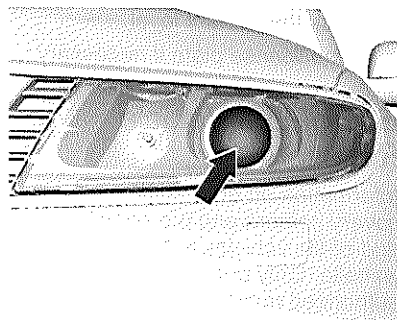

2. Locate the aim dot on the lens of the low-beam headlight.
3. Measure the distance from the ground to the aim dot on the low-beam headlight. Record the distance.

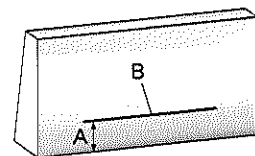

4. At the wall measure from the ground upward (A) to the recorded distance from Step 3 and mark it.
5. Draw or tape a horizontal line (B) on the wall the width of the vehicle at the height of the mark in Step 4.

Caution

Do not cover a headlamp to improve beam cut-off when aiming. Covering a headlamp could cause excessive heat build-up, which could damage the headlamp.

6. Turn on the low-beam headlights and place a piece of cardboard or equivalent in front of the headlight not being adjusted. This allows only the beam of light from the headlight being adjusted to be seen on the flat surface.

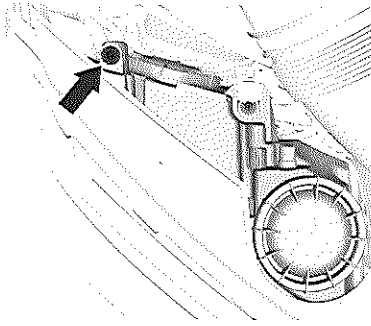

7. Locate the vertical headlight aiming screws, which are under the hood near each headlight assembly.
8. Turn the vertical aiming screw until the headlight beam is aimed to the horizontal tape line. Turn it

clockwise or counterclockwise to raise or lower the angle of the beam.

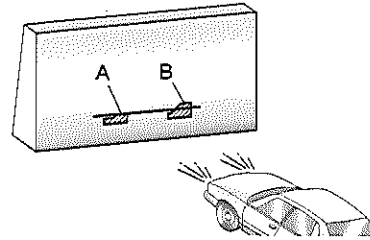

9. Make sure that the light from the headlight is positioned at the bottom edge of the horizontal tape line. The lamp on the left (A) shows the correct headlight aim. The lamp on the right (B) shows the incorrect headlight aim.
10. Repeat Steps 7 through 9 for the opposite headlight.

Vehicle Checks

Doing Your Own Service Work

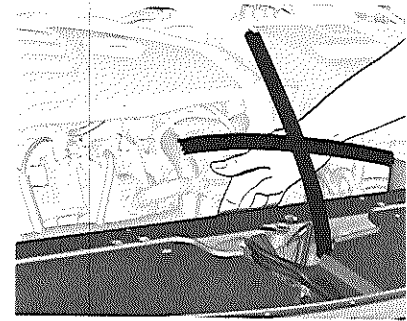

Warning

Only perform engine compartment checks when the ignition is off.

The cooling fan may start operating even if the ignition is off.

⚠ Danger

The ignition system and Xenon headlights use extremely high voltage. Do not touch.

Hood

Opening

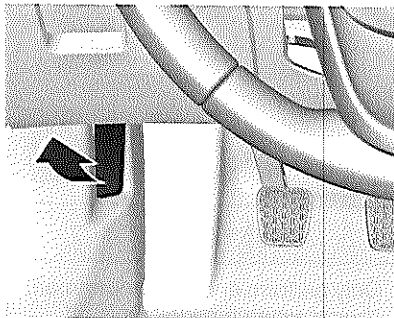

Pull the release lever and return it to its original position.

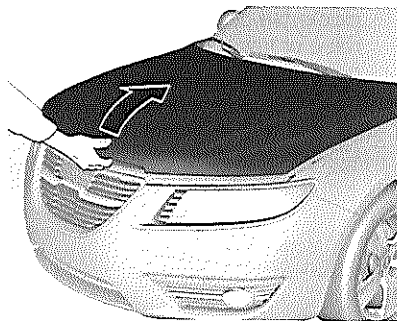

Push the safety catch to the right and open the hood.

The hood is held open automatically.

Air intake ⇨ 141.

Closing

Lower the hood and allow it to drop into the catch. Check that the hood is engaged.

Engine Compartment Overview

Gasoline engine 2.8 Turbo

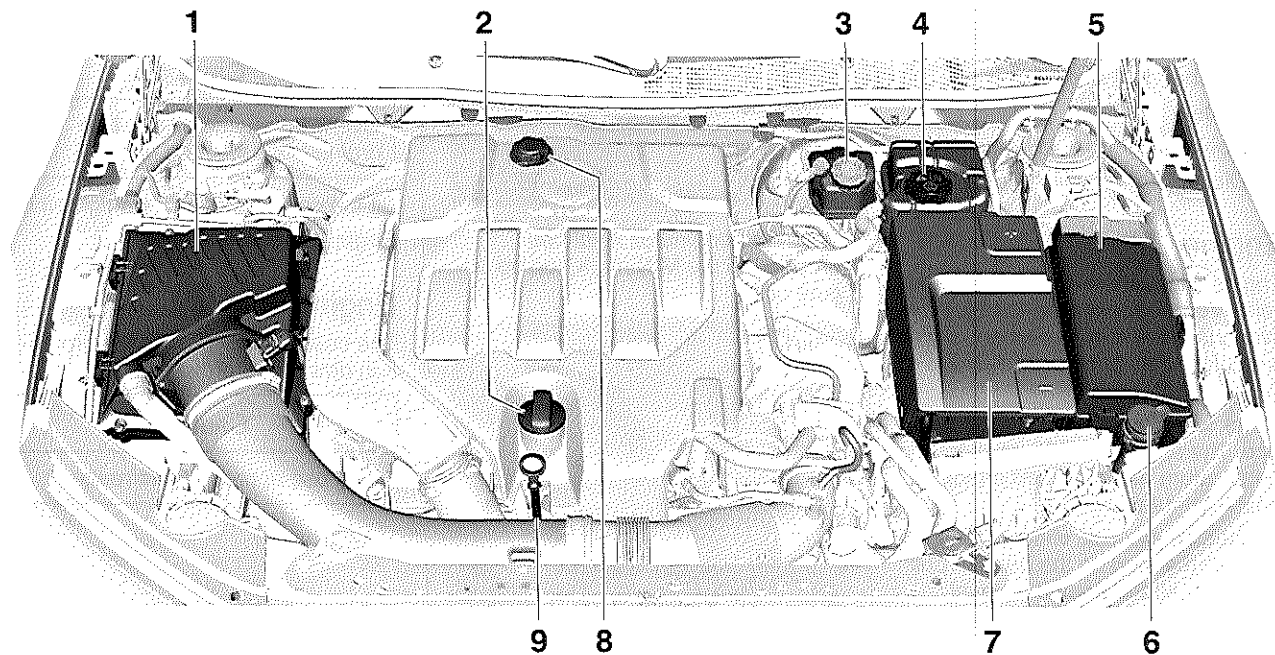

1. Engine air filter
2. Engine oil cap
3. Brake fluid container
4. Engine coolant container
5. Fuse box
6. Washer fluid container
7. Battery
8. Power steering fluid container
9. Dipstick for engine oil level

Engine Oil

Engine oil level is checked automatically, Vehicle messages ⇨ 111. However check the engine oil manually on a regular basis to prevent damage to the engine.

Check with the vehicle on a level surface. The engine must be at operating temperature and switched off for at least 5 minutes.

Pull out the dipstick, wipe it clean, insert it to the stop on the handle, pull out and read the engine oil level.

Insert dipstick to the stop on the handle and make half a turn.

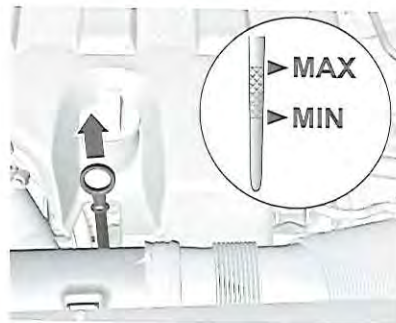

When the engine oil level has dropped to the **MIN** mark, top up engine oil.

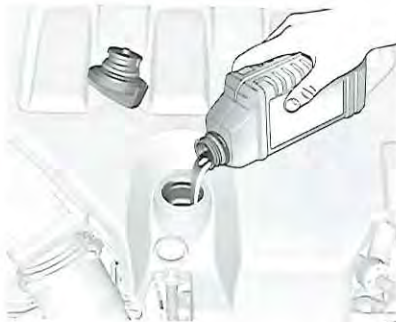

We recommend the use of the same grade of engine oil that was used at last change.

The engine oil level must not exceed the **MAX** mark on the dipstick.

Caution

Overfilled engine oil must be drained or suctioned out.

Fit the cap on straight and tighten it.
Engine oil quality ⇨ 224

Engine Coolant

The coolant provides freeze protection down to approx. -18°F.

Caution

Only use approved antifreeze.

Coolant level

Caution

Too low a coolant level can cause engine damage.

If the cooling system is cold, the coolant level should be above the filling line mark. Top up if the level is low.

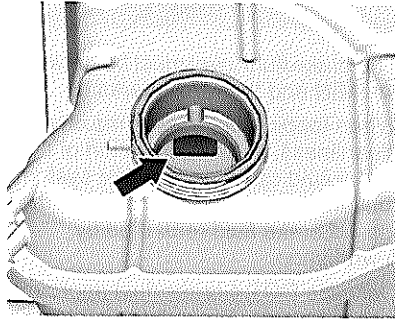

The filling line mark is inside the filler opening. To check open the cap.

⚠ Warning

Allow the engine to cool before opening the cap. Carefully open the cap, relieving the pressure slowly.

To top up use a 1:1 mixture of released coolant concentrate mixed with clean tap water. If no coolant concentrate is available, use clean tap water. Install the cap tightly. Have the coolant concentration checked and have the cause of the coolant loss remedied by a workshop.

Power Steering Fluid

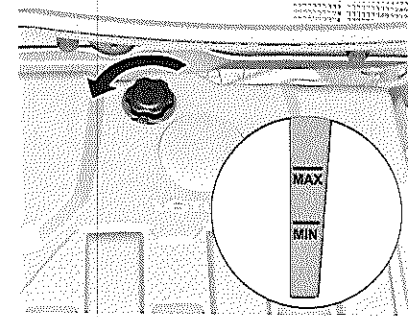

Open the cap and remove it. Wipe the dipstick clean and insert the dipstick in the container. Open the cap again, remove it and read the power steering fluid level.

The power steering fluid level must be between the **MIN** and the **MAX** marks.

If the fluid level is too low, seek the assistance of a workshop.

Power steering fluid ⇨ 224.

Washer Fluid



Fill with clean water mixed with a suitable quantity of windshield washer fluid which contains antifreeze. For the correct mixing ratio refer to the washer fluid container.

Low washer fluid is indicated by a warning message in the Driver Information Center.

Caution

Only washer fluid with a sufficient antifreeze concentration provides protection at low temperatures or a sudden drop in temperature.

Brakes

Once new brake linings are installed, do not brake unnecessarily hard for the first few journeys.

Brake Fluid

⚠ Warning

Brake fluid is poisonous and corrosive. Avoid contact with eyes, skin, fabrics and painted surfaces.



The brake fluid level must be between the **MIN** and the **MAX** marks.

When topping up, ensure maximum cleanliness, as contamination of the brake fluid can lead to brake system malfunctions. Have the cause of the loss of brake fluid remedied by a workshop.

Only use DOT 4 brake fluid approved for the vehicle, Brake fluid ↻ 224.

Battery

The vehicle battery is maintenance-free provided that the driving profile allows sufficient charging of the battery. Short-distance-driving and frequent engine starts can discharge the battery. Avoid the use of unnecessary electrical consumers.

⚠ Danger

Battery posts, terminals, and related accessories contain lead and lead compounds – chemicals known by the State of California to cause cancer and reproductive harm. Wash your hands after handling.



Batteries do not belong in household waste. They must be disposed of at an appropriate recycling collection point.

Laying up the vehicle for more than 4 weeks can lead to battery discharge. Disconnect the clamp from the negative terminal of the vehicle battery.

Ensure the ignition is switched off before connecting or disconnecting the vehicle battery.

The anti-theft alarm siren must be deactivated as follows: Switch the ignition on then off, disconnect the vehicle's battery within 15 seconds.

Battery discharge protection ⇨ 132.

Wiper Blade Replacement

Wiper blades on the windshield

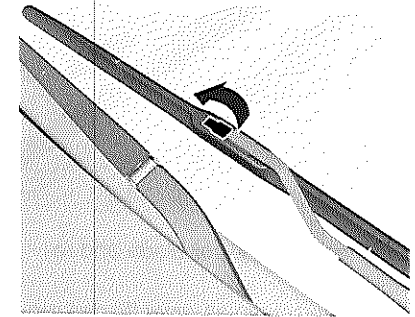

Lift the wiper arm, open the retaining clip.

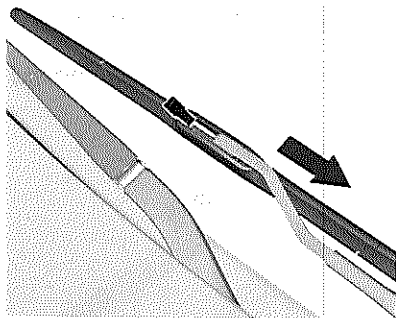

Disengage the wiper blade and remove.

Check and clean all wiper blades regularly. We recommend washer fluid for cleaning. If poor wiper performance is experienced, clean the windshield with washer fluid. This is particularly important if the car has been through an automatic car wash, as these sometimes leave a wax coating on the windshield. If wiper performance is still unsatisfactory, fit new blades.

Bulb Replacement

Switch off the ignition and switch off the relevant switch or close the doors.

Only hold a new bulb at the base! Do not touch the bulb glass with bare hands.

Use only the same bulb type for replacement.

Replace headlight bulbs from within the engine compartment.

Caution

Only on halogen headlight systems the bulbs can be replaced.

Halogen Headlamps

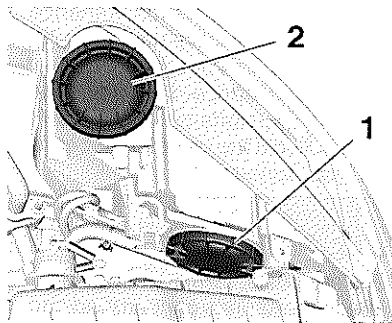

Headlamps have separate systems for high beam 2 (inner bulbs) and low beam 1 (outer bulbs).

Low beam

1. Rotate cap 1 anti-clockwise and remove.

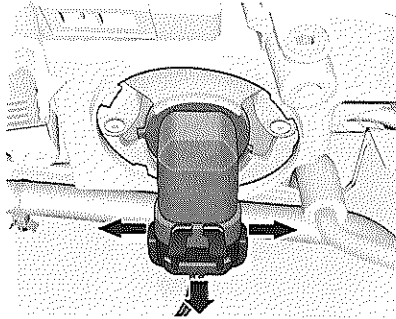

2. Disengage clips on the connector and take off the plug connector from the bulb. Rotate bulb anti-clockwise to disengage. Withdraw the bulb from the reflector.

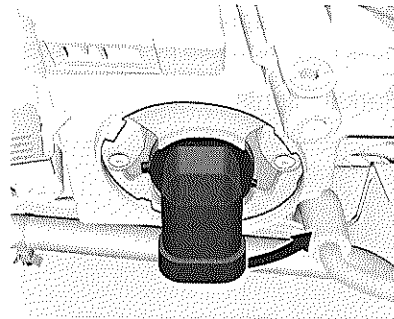

3. Insert the new bulb, engaging the two lugs into the reflector.
4. Rotate bulb carrier clockwise as far as it will go.
5. Clip on and engage connector to the bulb.
6. Fit cap and rotate clockwise.

High beam

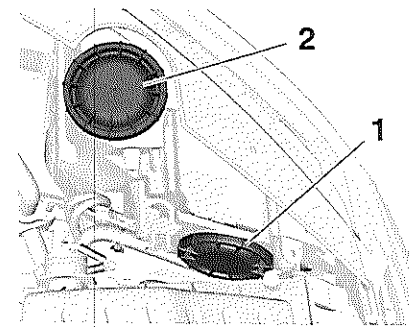

1. Rotate cap 2 anti-clockwise and remove.

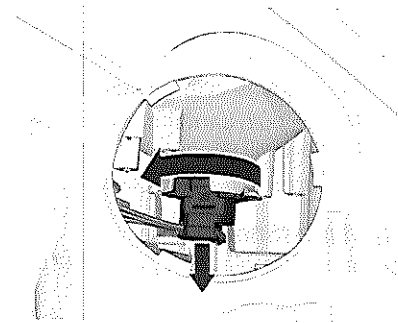

2. Rotate bulb holder anti-clockwise to disengage. Withdraw the bulb holder from the reflector.

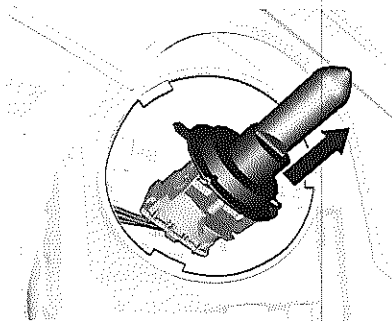

3. Detach bulb from bulb holder and renew the bulb.
4. Insert the bulb holder, engaging the two lugs into the reflector.
5. Rotate bulb carrier clockwise as far as it will go.
6. Fit cap and rotate clockwise.

Daytime running light

Have bulbs replaced by a workshop.

Front turn signal

Have bulbs replaced by a workshop.

Parking lights

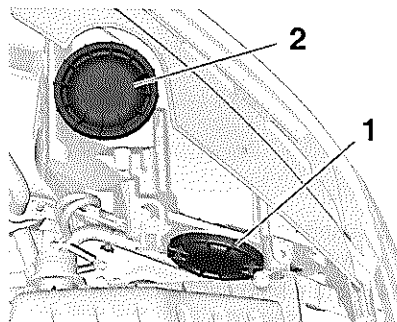

1. Rotate cap 2 anti-clockwise and remove.

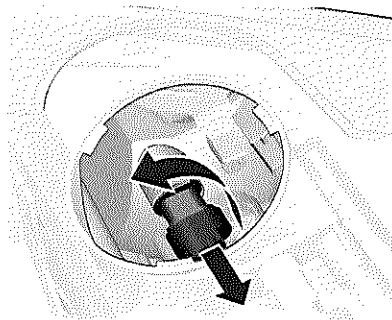

2. Rotate bulb holder anti-clockwise to disengage. Withdraw the bulb holder from the reflector.

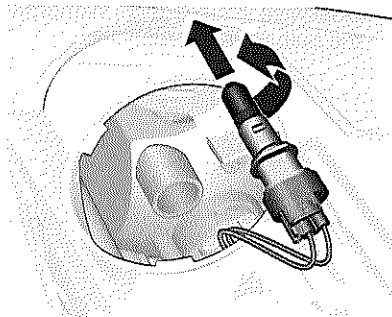

3. Push bulb into socket slightly, rotate anti-clockwise, remove and renew bulb.
4. Insert bulb holder in reflector, rotate clockwise to engage.
5. Fit cap and rotate clockwise.

Xenon Headlamps

⚠ Danger

Xenon headlamps work under extremely high electrical voltage. Do not touch. Have bulbs replaced by a workshop.

Daytime running light

Have bulbs replaced by a workshop.

Fog Lamps

Front Fog Lamps

Have bulbs replaced by a workshop.

Taillamps

Sedan

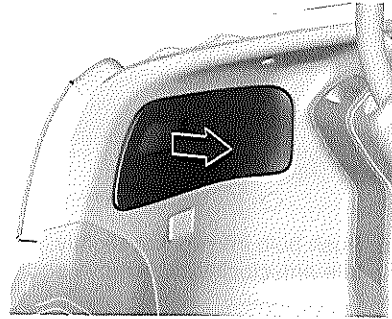

1. Release cover and remove.

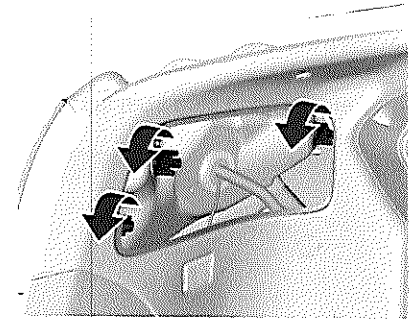

2. Unscrew three plastic securing nuts from the inside by hand.

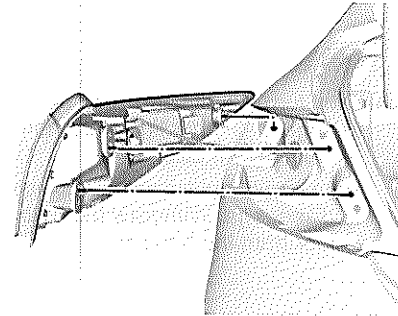

3. Remove tail light assembly. Take care that the cable duct remains in position.

Detach wiring plug from tail light housing.

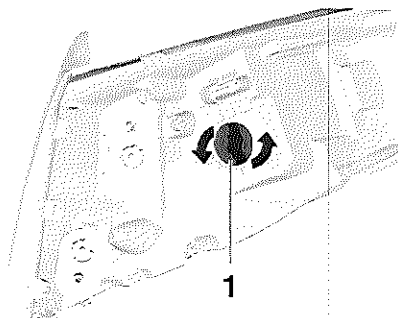

4. Only turn signal light 1 can be changed, all other lights are non exchangeable LEDs.

Rotate bulb holder anti-clockwise to disengage. Withdraw the bulb holder from the housing.

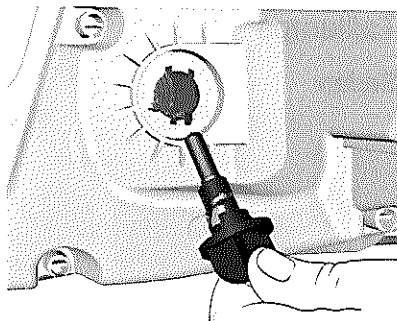

5. Push bulb into socket slightly, rotate anti-clockwise, remove and renew bulb.
6. Insert bulb holder into the tail light assembly, rotate clockwise to engage. Connect wiring plug.

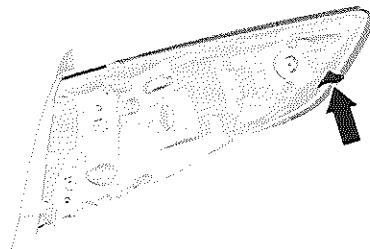

7. Install tail light assembly in body. Note that the assembly engages in the body correctly. Tighten securing nuts. Close cover and engage.
8. Switch on ignition, operate and check all lights.

Side Turn Signal Lamps

There are side turn signal lights in the housing of the exterior mirrors. These lights are non-exchangeable LEDs. Consult a workshop in the case of a defect.

Puddle lights in exterior mirrors

Have the bulbs replaced by a workshop.

License Plate Lamp

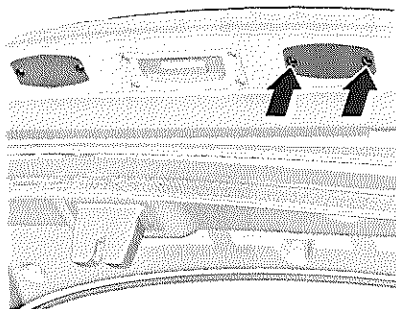

1. Turn out both screws.

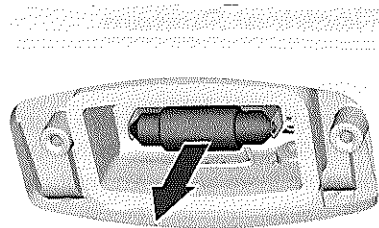

2. Press bulb slightly towards spring clip and remove.
3. Insert new bulb.
4. Install lamp.

Interior Lamps

Courtesy light, reading lights

Have bulbs replaced by a workshop.

Trunk light

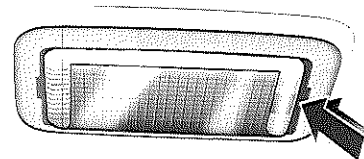

1. Prise the lamp out with a screwdriver.

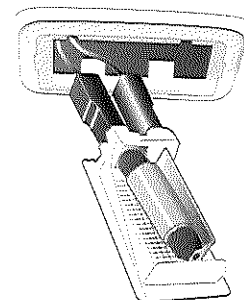

2. Press bulb slightly towards spring clip and remove.
3. Insert new bulb.
4. Install lamp.

Instrument Panel Illumination

Have bulbs replaced by a workshop.

Electrical System

Fuses

Data on the replacement fuse must match the data on the defective fuse. There are three fuse boxes in the vehicle:

- in the front left of the engine compartment,
- in the interior behind the storage compartment, or, in right-hand drive vehicles, behind the glove box,
- behind a cover on the left side of the trunk.

Before replacing a fuse, turn off the respective switch and the ignition.

A blown fuse can be recognized by its melted wire. Do not replace the fuse until the cause of the fault has been remedied.

Some functions are protected by several fuses.

Fuses may also be inserted without existence of a function.

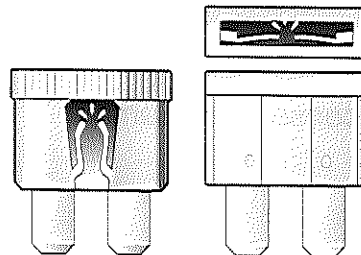

30040

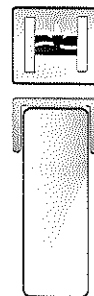

30041

Fuse extractor

A fuse extractor may be located in the fuse box in the engine compartment.

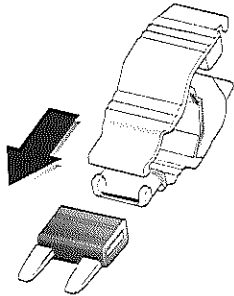

30042

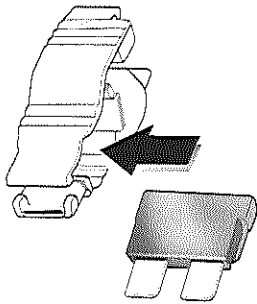

30042

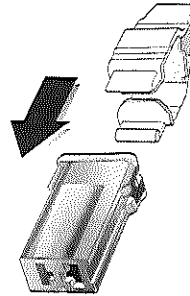

30044

Place the fuse extractor on the various types of fuse from the top or side, and withdraw fuse.

Engine Compartment Fuse Block

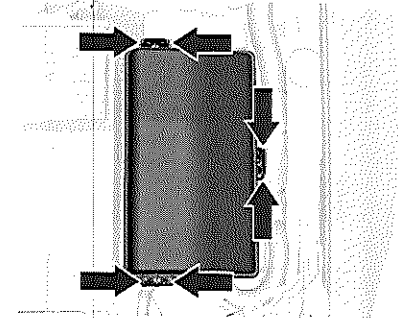

The fuse box is in the front left of the engine compartment.

Disengage the cover, lift it upwards and remove.

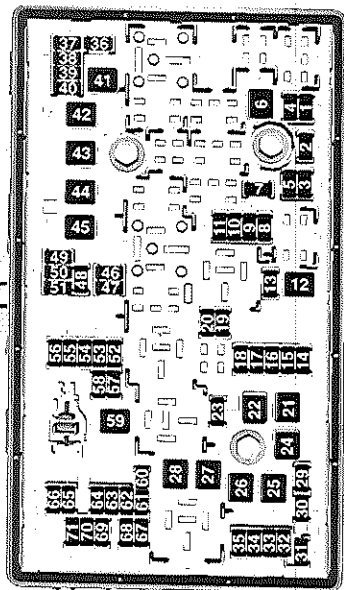

No. Circuit

- 1 Transmission control module
- 2 Engine control module
- 3 -
- 4 -
- 5 Ignition, Transmission control module, Engine control module
- 6 Windshield wiper
- 7 -
- 8 Fuel injection, ignition system
- 9 Fuel injection, ignition system
- 10 Engine control module
- 11 Lambda probe
- 12 Starter
- 13 Sensor throttle heating
- 14 Lighting
- 15 -

No. Circuit

- 16 Vacuum pump, Compass module
- 17 Ignition, Airbag
- 18 Adaptive forward lighting
- 19 Adaptive forward lighting
- 20 Ignition
- 21 Rear power windows
- 22 ABS
- 23 Variable effort steering
- 24 Front power windows
- 25 Power outlets
- 26 ABS
- 27 Electrical parking brake
- 28 Heated rear window
- 29 Left power seat
- 30 Right power seat
- 31 Air conditioning system

No. Circuit
32 Body control module
33 Heated front seats
34 -
35 Infotainment system
36 -
37 Right high beam
38 Left high beam
39 -
40 After boil pump
41 Vacuum pump
42 Radiator fan
43 -
44 Headlight washer system
45 Radiator fan
46 Terminal 87, main relay
47 Lambda probe
48 Fog lights

No. Circuit
49 Right low beam
50 Left low beam
51 Horn
52 Ignition
53 Ignition, ventilated front seats
54 Ignition
55 Power windows, mirror folding
56 Windshield washer
57 Ignition
58 -
59 -
60 Mirror heating
61 Mirror heating
62 Canister Vent Solenoid
63 Rear window sensor
64 Adaptive forward lighting
65 Horn

No. Circuit
66 -
67 Fuel system control module
68 -
69 Battery sensor
70 Rain sensor
71 Body electronic supply

After changing of defective fuses close the fuse box cover and let it engage by pressing.
If the fuse box cover is not closed correctly, malfunction may occur.

Instrument Panel Fuse Block

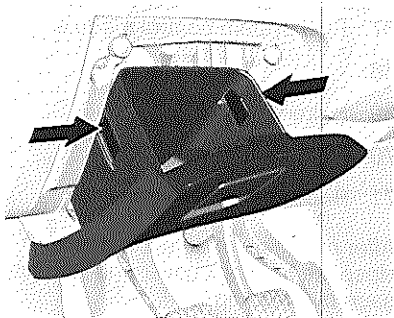

The fuse box is behind the storage compartment in the instrument panel. Open compartment, compress the locking tabs, fold compartment down and remove.

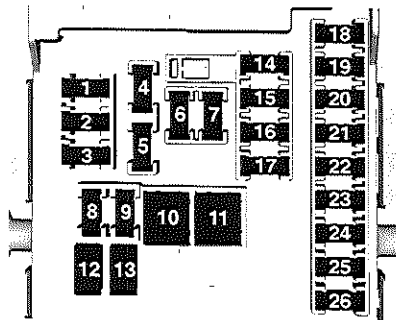

No. Circuit

- | | |
|---|-----------------------------------|
| 1 | Infotainment system, Info display |
| 2 | Body control unit |
| 3 | Body control unit |
| 4 | Infotainment system, Info display |
| 5 | Infotainment system, Info display |
| 6 | - |
| 7 | Power outlet |

No. Circuit

- | | |
|----|-------------------------|
| 8 | Body control unit |
| 9 | Body control unit |
| 10 | Body control unit |
| 11 | Interior fan |
| 12 | - |
| 13 | - |
| 14 | Diagnostic connector |
| 15 | Airbag |
| 16 | Central locking system |
| 17 | Air conditioning system |
| 18 | Transportation fuse |
| 19 | Memory |
| 20 | - |
| 21 | Instrument |
| 22 | Ignition |
| 23 | Body control unit |
| 24 | Body control unit |

No. Circuit

25 -

26 Power outlet trunk

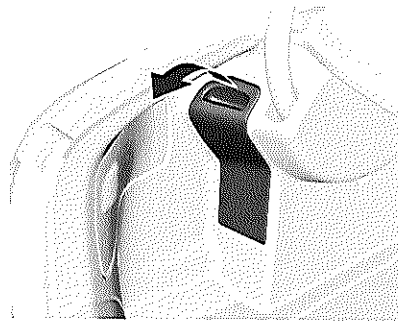
Rear Compartment Fuse Block

The fuse box is on the left side of the trunk behind the storage box. Remove the cover of the storage box.

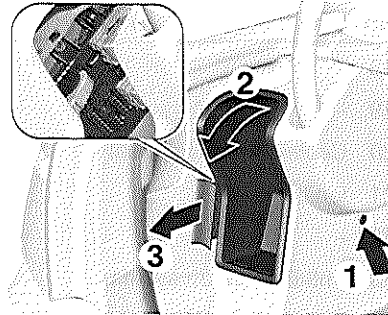

To remove the storage box,

- pull out the center part of the rivet and then pull out the complete rivet (1)
- pull out the storage box while tilting downwards (2)
- to get full access to the fuse box, fold out the pre-cut flap (3).

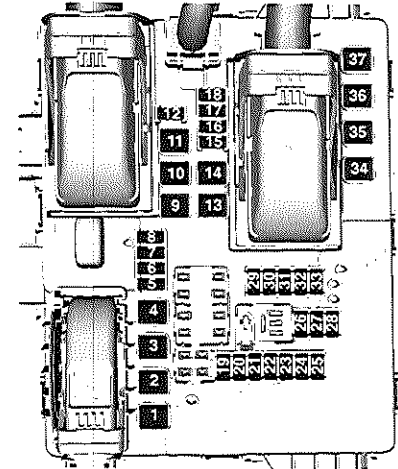

188 Vehicle Care

No. Circuit

- 1 Central locking system
- 2 Air conditioning system
- 3 -
- 4 -
- 5 -
- 6 -
- 7 -
- 8 -
- 9 -
- 10 Coolant heater
- 11 Power seats
- 12 Memory seat
- 13 -
- 14 -
- 15 -
- 16 -
- 17 Seat heating

No. Circuit

- 18 -
- 19 -
- 20 Cooling fan driver seat
- 21 Ignition
- 22 -
- 23 Anti-theft alarm system
- 24 Parking light left
- 25 Parking light right
- 26 Lighting
- 27 Lighting
- 28 -
- 29 Transportation fuse
- 30 Transportation fuse
- 31 Suspension system, High beam assist, Cruise control, Lane departure warning
- 32 Side obstacle detector

No. Circuit

- 33 Cross-wheel drive
- 34 -
- 35 Central locking system
- 36 Power seats
- 37 -

Vehicle Tools

Tools

Vehicles with tire repair kit

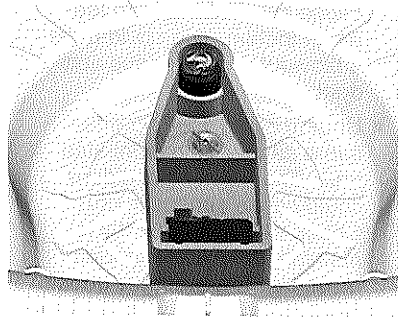

The tools and tire repair kit are in a storage compartment below the floor cover in the trunk.

Vehicles with spare tire

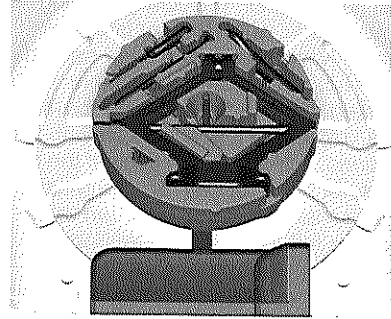

The jack and the tools are in a storage compartment in the trunk below the spare tire. Spare tire ⇨ 215.

Wheels and Tires

Tire condition, wheel condition

Drive over edges slowly and at right angles if possible. Driving over sharp edges can cause tire and wheel damage. Do not trap tires on the curb when parking.

Regularly check the wheels for damage. Seek the assistance of a workshop in the event of damage or unusual wear.

Tire inspection and rotation

Tires should be rotated every 10,000 miles.

Any time you notice unusual wear, rotate your tires as soon as possible and check wheel alignment. Also check for damaged tires or wheels.

The purpose of regular rotation is to achieve more uniform wear for all tires on the vehicle. The first rotation is the most important.

When rotating your tires, always use the correct rotation pattern. Left front tire to left rear. Left rear tire to right front. Right front to right rear. Right rear to left front.

Don't include the compact spare tire in your tire rotation.

After the tires have been rotated, adjust the front and rear inflation pressures as shown on the Tire-Loading Information label. Make certain that all wheel nuts are properly tightened.

⚠ Warning

Rust or dirt on a wheel or on the parts to which it is fastened could make wheel nuts loosen over time. The wheel could come off and cause an accident. When changing a wheel, remove any rust or dirt from places where the wheel attaches to the vehicle. In an emergency, use a cloth or a paper towel to do this; but be sure to use a scraper or wire brush later, if needed, to get all the rust or dirt off.

Flat spotting

All tires get hot, especially on long journeys or when the car is driven hard. After the car has been parked with hot tires and the tires have cooled down, a flat spot can form in the tire, where it is in contact with the ground. The same can occur if the car has not been moved for a long time. Flat spots can cause vibration that can be felt through the steering wheel, similar to that experienced when the wheels need balancing. Flat spots of this type disappear once the tires get hot again, usually after 10-15 miles of driving at cruising speed. If the outdoor temperature is low it takes a longer distance.

Tires

Your new vehicle comes with high-quality tires made by a leading tire manufacturer. If you ever have questions about your tire warranty and where to obtain service, see your Saab Warranty and Service Record Booklet for details.

⚠ Warning

Poorly maintained and improperly used tires are dangerous.

- Overinflating your tires could cause overheating from too much friction. You could have a blowout and a serious accident.
- Underinflated tires pose the same danger as overinflated tires. The resulting accident could cause serious injury. Check all tires frequently to maintain the recommended pressure. Tire pressure should be checked when your tires are cold.
- Overinflated tires are more likely to be cut, punctured or broken by a sudden impact - such as

when you hit a pothole. Keep tires at the recommended pressure.

- Worn, old tires could cause accidents. Replace your tires if the tread is badly worn or if they have been damaged.

High speed operation

⚠ Warning

Driving at high speeds, 100 mph or higher, puts an additional strain on tires. Prolonged high-speed driving causes excessive heat build-up and could cause sudden tire failure. You could have a collision and you or others could be killed. Some high-speed rated tires require inflation pressure adjustment for high-speed operation. When speed limits and road conditions are such that a vehicle can be driven at high speeds, make sure the tires are rated for high-speed operation, are in excellent condition, and are set to the correct cold tire inflation pressure for the vehicle load.

If you'll be driving at high speeds, speeds of 100 mph or higher, where it is legal, set the cold inflation pressure to the maximum inflation pressure shown on the tire sidewall, or to 35 psi, whichever is lower. See the

example below. When you end this high-speed driving, return to the cold inflation pressure shown on the tire-loading information label.

Example

You'll find maximum load and inflation pressure molded on the tire's sidewall, in small letters near the rim flange. It will read something like this: Maximum load 1521 lbs., Max. Press 44 psi.

For this example, you would set the inflation pressure for high-speed driving at 35 psi.

Uniform Tire Quality Grading

Quality grades can be found, where applicable, on the tire sidewall between tread shoulder and maximum section width. For example:

Treadwear 200 Traction AA Temperature A

The following information relates to the system developed by the United States National Highway Traffic Safety Administration, which grades tires by treadwear, traction and temperature performance. The grades

are molded on the sidewalls of most passenger car tires. The Uniform Tire Quality Grading system does not apply to deep tread, winter-type snow tires, space-saver or temporary use spare tires, tires with nominal rim diameters of 10 to 12 inches, or to some limited-production tires.

Treadwear

The treadwear grade is a comparative rating based on the wear rate of the tire when tested under controlled conditions on a specified government test course. For example, a tire graded 150 would wear one and a half (1.5) times as well on the government course as a tire graded 100. The relative performance of tires depends upon the actual conditions of their use, however, and may depart significantly from the norm due to variations in driving habits, service practices and differences in road characteristics and climate.

Traction - AA, A, B, C

The traction grades, from highest to lowest, are AA, A, B, and C. Those grades represent the tire's ability to stop on wet pavement as measured

under controlled conditions on specified government test surfaces of asphalt and concrete. A tire marked C may have poor traction performance. Warning: The traction grade assigned to this tire is based on straight-ahead braking traction tests, and does not include acceleration, cornering, hydroplaning, or peak traction characteristics.

Temperature - A, B, C

⚠ Warning

The temperature grade for this tire is established for a tire that is properly inflated and not overloaded. Excessive speed, underinflation, or excessive loading, either separately or in combination, could cause heat buildup and possible tire failure.

The temperature grades are A (the highest), B, and C, representing the tire's resistance to the generation of heat and its ability to dissipate heat when tested under controlled conditions on a specified indoor laboratory

test wheel. Sustained high temperature can cause the material of the tire to degenerate and reduce tire life, and excessive temperature can lead to sudden tire failure. The grade C corresponds to a level of performance which all passenger car tires must meet under the Federal Motor Vehicle Safety Standard No. 109. Grades B and A represent higher levels of performance on the laboratory test wheel than the minimum required by law.

If a tire goes flat

It's unusual for a tire to "blowout" while you're driving, especially if you maintain your tires properly. If air goes out of a tire, it's much more likely to leak out slowly. But if you should ever have a "blowout", here are a few tips about what to expect and what to do:

If a front tire fails, the flat tire will create a drag that pulls the vehicle toward that side. Take your foot off the

accelerator pedal and grip the steering wheel firmly. Steer to maintain lane position, and then gently brake to a stop, well out of the traffic lane.

A rear blowout, particularly on a curve, acts much like a skid and may require the same correction you'd use in a skid. In any rear blowout, remove your foot from the accelerator pedal. Get the vehicle under control by steering the way you want the vehicle to go. It may be very bumpy and noisy, but you can still steer. Gently brake to a stop - well off the road if possible.

If a tire goes flat, the next part shows how to use your jacking equipment to change a flat tire safely.

Loading your vehicle

TIRE AND LOADING INFORMATION				
SEATING CAPACITY		TOTAL W	FRONT W	REAR W
The combined weight of occupants and cargo should never exceed 000 lb or 000 kg.				
TIRE	SIZE	COLD TIRE PRESSURE	SEE OWNER'S MANUAL FOR ADDITIONAL INFORMATION	
FRONT	000/0000 000	000 kPa, 00 PSI		
REAR	000/0000 000	000 kPa, 00 PSI		
SPARE	0000/00000 00	000 kPa, 00 PSI		

This is an example of what your vehicle's tire-loading information/certification label might look like. It is located on the B-pillar and shows how much weight your vehicle may properly carry. The label tells you the proper size and recommended inflation pressures for the tires on your vehicle. It also gives you important information about the number of people that can be in your vehicle and the total weight that you can carry. This weight is called the Vehicle Capacity Weight,

and includes the weight of all occupants, cargo and all nonfactory-installed options.

Tire terminology and definitions

Air pressure : The amount of air inside the tire pressing outward on each square inch of the tire. Air pressure is expressed in pounds per square inch (psi) or bar.

Accessory weight : This means the combined weight of optional accessories, for example, automatic transmission, power steering, power brakes, power windows, power seats, radio and air conditioning.

Aspect ratio : The relationship of a tire's height to its width.

Belt : A rubber coated layer of cords that is located between the plies and the tread. Cords may be made from steel or other reinforcing materials.

Bias ply tire : A pneumatic tire in which the ply cords that extend to the beads are laid at alternate angles substantially less than 90 degrees to the centerline of the tread.

Cold inflation pressure : The amount of air pressure in a tire, measured in pounds per square inch (psi) or bar, before a tire has built up heat from driving.

Curb weight : This means the weight of a motor vehicle with standard and optional equipment including the maximum capacity of fuel, oil and coolant, without passengers and cargo.

DOT markings : A code molded into the sidewall of a tire signifying that the tire is in compliance with the U.S. Department of Transportation motor vehicle safety standards. The DOT code includes the Tire Identification Number (TIN), an alphanumeric designator which can also identify the tire manufacturer, production plant, brand and date of production.

GVWR : Gross Vehicle Weight Rating.

GAWR FRT : Gross Axle Weight Rating for the front axle.

GAWR RR : Gross Axle Weight Rating for the rear axle.

Intended outboard sidewall : The side of an asymmetrical tire that must always face outward when mounted on a vehicle.

Light Truck (LT-Metric) tire : A tire used on light duty trucks and some multipurpose passenger vehicles.

Load index : An assigned number ranging from 1 to 279 that corresponds to the load carrying capacity of a tire.

Maximum load rating : The load rating for a tire at the maximum permissible inflation pressure for that tire.

Maximum loaded vehicle weight : The sum of curb weight, accessory weight, vehicle capacity weight, and production options weight.

Maximum permissible inflation pressure : The maximum cold inflation pressure to which a tire may be inflated.

Normal occupant weight : The number of occupants a vehicle is designed to seat multiplied by 150 pounds.

Occupant distribution : Designated seating positions.

Outward facing sidewall : The side of a asymmetrical tire that has a particular side that faces outward when mounted on a vehicle. The side of the tire that contains a whitewall bears white lettering or bears manufacturer, brand and/or model name molding on the other sidewall of the tire.

Passenger (P-Metric) tire : A tire used on passenger cars and some light duty trucks and multipurpose vehicles.

Recommended inflation pressure : Vehicle manufacturer's recommended tire inflation pressure shown on the tire placard.

Radial ply tire : A pneumatic tire in which the ply cords that extend to the beads are laid at 90 degrees to the centerline of the tread.

Rim : A metal support for a tire or a tire and tube assembly upon which the tire beads are seated.

Sidewall : The portion of a tire between the tread and the bead.

Speed rating : An alphanumeric code assigned to a tire indicating the maximum speed at which a tire can operate.

Traction : The friction between the tire and the road surface. The amount of grip provided.

Treadwear indicators : Narrow bands, sometimes called "wear bars", that show across the tread of a tire when only 2/32 inch of tread remains.

Tread width : The width of the tire's tread.

UTQGS : Uniform Tire Quality Grade Standards, a tire information system that provides consumers with ratings for a tire's traction, temperature and treadwear. Ratings are determined by tire manufacturers using government testing procedures. The ratings are molded into the sidewall of the tire.

Vehicle capacity weight : The number of designated seating positions multiplied by 150 pounds plus the rated cargo load.

Vehicle maximum load on the tire : Load on an individual tire due to curb weight, accessory weight, occupant weight and cargo weight.

Vehicle placard : A label permanently attached to a vehicle showing original equipment tire size and the recommended cold inflation pressure.

Steps for determining correct load limit

1. Locate the statement "The combined weight of occupants and cargo should never exceed XXX pounds" on your vehicle's placard.
2. Determine the combined weight of the driver and passengers that will be riding in your vehicle.
3. Subtract the combined weight of the driver and passengers from XXX kilograms or XXX pounds.
4. The resulting figure equals the available amount of cargo and luggage load capacity. For example, if the "XXX" amount equals 1400 lbs and there will be five 150 lb passengers in your vehicle,

the amount of available cargo and luggage load capacity is 650 lbs

(1400-750 (5x150) = 650 lbs).

5. Determine the combined weight of luggage and cargo being loaded on the vehicle. That weight may not safely exceed the available cargo and luggage load capacity calculated in step four.
6. If your vehicle will be towing a trailer, load from your trailer will be transferred to your vehicle. Consult this manual to determine how this reduces the available cargo and luggage load capacity of your vehicle.

Winter Tires

Winter tires improve driving safety at temperatures below 45° F and should therefore be fitted on all wheels.

Winter tires should be fitted to all four wheels to maintain a proper balance. Tires of size 225/55 R 17,

225/50 R 17, 235/45 R 18, 245/40 R 18 and 245/45 R 18 can be used as winter tires.

Tires of size 245/40 R 19 must not be used as winter tires.

Your Saab dealer can supply Saab approved winter tires pre-mounted on steel or alloy rims. Winter tires normally use a different speed rating compared to summer/all season tires. Make sure not to exceed the stated speed rating on the tires you use. Make sure that wheels with sensors for tire pressure monitoring are fitted during replacement if the car has automatic tire pressure monitoring.

In accordance with country-specific regulations, affix the speed sticker in the driver's field of view.

Tire chains ⇨ 207.

Tire date code

Tires should be regarded as perishable goods. As the tires age, the rubber becomes progressively harder, and the road holding ability of the tires diminishes. This is particularly true on winter tires.

Tires have a code that specifies their date of manufacture. The first two digits denote the week number and the last two digits the year followed by a filled triangle.

Tire Designations

Tire sidewall labeling

Useful information about a tire is molded into its sidewall.

Tire size : The tire size is a combination of letters and numbers used to define a particular tire's width, height, aspect ratio, construction type and service description.

Department of transportation (DOT) : The Department of Transportation (DOT) code indicates that the tire is in compliance with the U.S. Department of Transportation Motor Vehicle Safety standards.

Tire identification number (TIN) : The letters and numbers following DOT code are the Tire Identification Number (TIN). The TIN shows the manufacturer and plant code, tire size, and

date the tire was manufactured. The TIN is molded onto both sides of the tire.

Tire ply material : The type of cord and number of plies in the sidewall and under the tread.

Uniform Tire Quality Grading (UTQG) : Tire manufacturers are required to grade tires based on the performance factors: treadwear, traction and temperature resistance.

Maximum cold inflation load Limit : Maximum load that can be carried and the maximum pressure needed to support that load.

Tire size

Following example shows the designation of a typical passenger car tire size:

E.g. 225/55 R 17 95 W

- 225 = Tire section width, mm
- 55 = Aspect ratio, i.e. the section height as a percentage of the section width, %
- R = Belt rating, radial
- 17 = Rim diameter, inches
- 95 = Load range e.g. 95 is equivalent to 1521 lbs.
- W = Speed rating

Tire width : The three-digit number indicates the tire section width in millimeters from sidewall to sidewall.

Aspect ratio : A two-digit number that indicates the tire height-to-width measurements. For example, if the tire size aspect ratio is "55", as shown in the example above, it would mean that the tire's sidewall is 55 % as high as it is wide.

Belt rating : A letter code is used to indicate the type of ply construction in the tire. The letter "R" means radial ply construction; the letter "D" means diagonal or bias ply construction; and the letter "B" means belted-bias ply construction.

Rim diameter : Diameter of the wheel in inches.

Load range : The load range represents the load carry capacity a tire is certified to carry.

Speed rating : The maximum speed that a tire is certified to carry a load. Speed ratings range from "A" to "Z".

Tire load indices

- 91 = Tire approved for max. 1355 lbs.
- 93 = Max. 1433 lbs.
- 94 = Max. 1477 lbs.
- 95 = Max. 1521 lbs.
- 97 = Max. 1609 lbs.
- 98 = Max. 1653 lbs.

Speed code letter:

- Q = Tire approved for speeds up to 100 mph.
- S = Max. up to 112 mph.
- T = Max. up to 118 mph.
- H = Max. up to 130 mph.
- V = Max. up to 150 mph.
- W = Max. up to 168 mph.
- Y = Max. up to 186 mph.

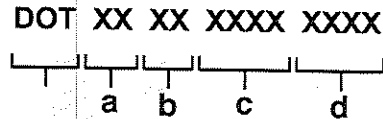

The illustration above shows the TIN-code.

- a = Manufacturer's identification mark.
- b = Tire size.
- c = Tire type code.
- d = Date of manufacture.

Tire Pressure

When to check

Check the pressure of cold tires at least every 14 days and before any long journey. Do not forget the spare tire. It should be at 60 psi. This also applies to vehicles with tire pressure monitoring system.

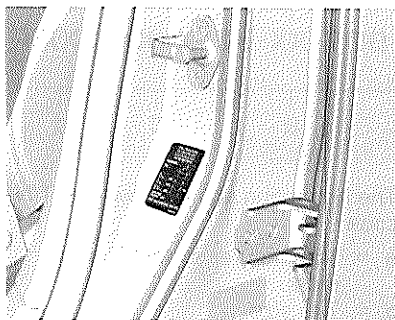

Tire pressure on the label on the front left door frame.

The tire pressure data refers to cold tires. It applies to summer and winter tires.

How to check

Use a good quality pocket-type gage to check tire pressure. You can't tell if your tires are properly inflated simply by looking at them. Radial tires may look properly inflated even when they're underinflated. Be sure to put the valve caps back on the valve stems. They help prevent leaks by keeping out dirt and moisture.

Always inflate the spare tire to the pressure specified for full load.

The ECO tire pressure serves to achieve the smallest amount of fuel consumption possible.

Incorrect tire pressures will impair safety, vehicle handling, comfort and fuel economy and will increase tire wear.

⚠ Warning
Tire pressure that is too low can result in considerable tire warm-up and internal damage, leading to tread separation and even to tire blowout at high speeds.

If the tire pressure shall be reduced or increased on a vehicle with tire pressure monitoring system, switch off ignition.

Inflation - Tire pressure

The tire-loading information label shows the correct inflation pressures for your tires when they're cold. "Cold"

means your vehicle has been sitting for at least three hours or driven no more than one mile.

Notice

Do not let anyone tell you that underinflation or overinflation is all right. It is not. Too little air in your tires (underinflation) could result in the following:

- Too much flexing.
- Too much heat.
- Tire overloading.
- Poor wear.
- Poor handling.
- Poor fuel economy.

Too much air in your tires (overinflation) could result in the following:

- Unusual wear.
- Poor handling.
- Rough ride.
- Needless damage from road hazards.

Adjust the tire pressure to match the current load and speed of the car. The stating tire pressures apply to cold

tires, i.e. tires that are the same temperature as the outside air temperature. Tire pressure increases as the tires become warm (e.g. during highway driving) by approximately 4 psi. When the temperature of the tires changes by 50 °F, the tire pressure will change 2 psi.

Never reduce the pressure of a hot tire. If the tires are hot when you check them, only increase the pressure if necessary.

Tire Pressure Monitoring System

The tire pressure monitor system (TPMS) uses radio and sensor technology to check tire pressure levels. The TPMS sensors monitor the air pressure in your vehicle's tires and transmit tire pressure readings to a receiver located in the vehicle.

Each tire, including the spare (if provided), should be checked monthly when cold and inflated to the inflation pressure recommended by the vehicle manufacturer on the vehicle plac-

ard or tire inflation pressure label. (If your vehicle has tires of a different size than the size indicated on the vehicle placard or tire inflation pressure label, you should determine the proper tire inflation pressure for those tires).

As an added safety feature, your vehicle has been equipped with a TPMS that illuminates a low tire pressure telltale when one or more of your tires is significantly under-inflated.

Accordingly, when the low tire pressure telltale illuminates, you should stop and check your tires as soon as possible, and inflate them to the proper pressure. Driving on a significantly under-inflated tire causes the tire to overheat and can lead to tire failure. Under-inflation also reduces fuel efficiency and tire tread life, and may affect the vehicle's handling and stopping ability.

Please note that the TPMS is not a substitute for proper tire maintenance, and it is the driver's responsibility to maintain correct tire pressure, even if under-inflation has not

reached the level to trigger illumination of the TPMS low tire pressure telltale.

Your vehicle has also been equipped with a TPMS malfunction indicator to indicate when the system is not operating properly. The TPMS malfunction indicator is combined with the low tire pressure telltale. When the system detects a malfunction, the telltale will flash for approximately one minute and then remain continuously illuminated. This sequence will continue upon subsequent vehicle startups as long as the malfunction exists \diamond 101.

When the malfunction indicator is illuminated, the system may not be able to detect or signal low tire pressure as intended. TPMS malfunctions may occur for a variety of reasons, including the installation of replacement or alternate tires or wheels on the vehicle that prevent the TPMS from functioning properly. Always check the TPMS malfunction telltale after replacing one or more tires or wheels on

your vehicle to ensure that the replacement or alternate tires and wheels allow the TPMS to continue to function properly.

Tire pressure monitor operation

This vehicle may have a tire pressure monitor system (TPMS). The TPMS is designed to warn the driver when a low tire pressure condition exists. TPMS sensors are mounted onto each tire and wheel assembly, excluding the spare tire and wheel assembly. The TPMS sensors monitor the air pressure in the vehicle's tires and transmit the tire pressure readings to a receiver located in the vehicle \diamond 101.

When a low tire pressure condition is detected, the TPMS illuminates the low tire pressure warning light located on the instrument panel cluster.

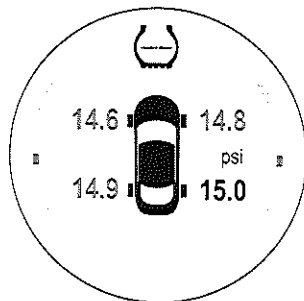

At the same time a message to check the pressure in a specific tire appears on the Driver Information Center (DIC) display. The low tire pressure warning light and the DIC warning message come on at each ignition cycle until the tires are inflated to the correct inflation pressure. Using the DIC, tire pressure levels can be viewed by the driver.

The low tire pressure warning light may come on in cool weather when the vehicle is first started, and then turn off as you start to drive. This could be an early indicator that the air

pressure in the tire(s) are getting low and need to be inflated to the proper pressure.

A tire-loading information label, attached to your vehicle, shows the size of your vehicle's original equipment tires and the correct inflation pressure for your vehicle's tires when they are cold.

Your vehicle's TPMS can warn you about a low tire pressure condition but it does not replace normal tire maintenance.

Caution

Using non-approved tire sealants could damage the tire pressure monitoring system (TPMS) sensors. Sensor damage caused by using a tire sealant is not covered by your warranty. Always use the approved tire sealant available through your workshop or included in the vehicle. Factory-installed tire repair kits use an approved liquid tire sealant.

TPMS Malfunction Light and Message

The TPMS will not function properly if one or more of the TPMS sensors are missing or inoperable. When the system detects a malfunction, the low tire warning light flashes for about one minute and then stays on for the remainder of the ignition cycle. A DIC warning message is also displayed. The low tire warning light and DIC warning message come on at each ignition cycle until the problem is corrected. Some of the conditions that can cause the malfunction light and DIC message to come on are:

- One of the road tires has been replaced with the spare tire. The spare tire does not have a TPMS sensor. The TPMS malfunction light and DIC message should go off once you re-install the road tire containing the TPMS sensor.
- The TPMS sensor matching process was started but not completed or not completed successfully after rotating the vehicle's tires. The DIC message and TPMS malfunction

light should go off once the TPMS sensor matching process is performed successfully. See "TPMS Sensor Matching Process" later in this section.

- One or more TPMS sensors are missing or damaged. The DIC message and the TPMS malfunction light should go off when the TPMS sensors are installed and the sensor matching process is performed successfully. Seek the assistance of a workshop.
- Replacement tires or wheels do not match your vehicle's original equipment tires or wheels. Tires and wheels other than those recommended for your vehicle could prevent the TPMS from functioning properly.
- Operating electronic devices or being near facilities using radio wave frequencies similar to the TPMS could cause the TPMS sensors to malfunction.

If the TPMS is not functioning it cannot detect or signal a low tire condition. Seek the assistance of a work-

shop if the TPMS malfunction light and DIC message comes on and stays on.

TPMS sensor matching process

Each TPMS sensor has a unique identification code. Any time you rotate your vehicle's tires or replace one or more of the TPMS sensors, the identification codes will need to be matched to the new wheel position. The sensors are matched to the wheel positions in the following order: driver side front tire, passenger side front tire, passenger side rear tire, and driver side rear tire using a TPMS diagnostic tool. Seek the assistance of a workshop.

The TPMS sensors can also be matched to each tire/wheel position by increasing or decreasing the tire's air pressure. If increasing the tire's air pressure, do not exceed the maximum inflation pressure indicated on the tire's sidewall.

To decrease air pressure out of a tire you can use the pointed end of the valve cap, a pencil-style air pressure gage, or a key.

You have two minutes to match the first wheel position, and five minutes overall to match all four wheel positions. If it takes longer than two minutes to match the first wheel, or more than five minutes to match all four wheel positions, the matching process stops and you need to start over.

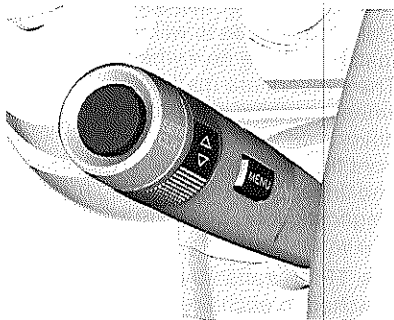

The TPMS sensor matching process is outlined below:

1. Set the parking brake and set the selector lever in the **P** position.
2. Turn the ignition on.
3. Press the **MENU** button to select the **Vehicle Information Menu**.

4. Turn the adjuster wheel to select the tire pressure monitoring system.

5. Press the **SET/CLR** button for 3 seconds to begin the sensor matching process.

A message asking if you are sure you want to begin this process should appear.

6. Press the **SET/CLR** button again to confirm the selection.

The horn sounds twice, the corresponding turn signal is also illuminated to signal the receiver is in relearn mode and **Tire Learning Active** appears in the Driver Information Center.

7. Start with the driver side front tire.

8. Remove the valve cap from the valve cap stem. Activate the TPMS sensor by increasing or decreasing the tire's air pressure for five seconds, or until a horn chirp sounds. The horn chirp, which may take up to 30 seconds to sound, confirms that the sensor

identification code has been matched to this tire and wheel position.

9. Proceed to the passenger side front tire, and repeat the procedure in step 8.
10. Proceed to the passenger side rear tire, and repeat the procedure in step 8.
11. Proceed to the driver side rear tire, and repeat the procedure in step 8. The horn sounds twice to indicate the sensor identification code has been matched to the driver side rear tire, and the TPMS sensor matching process is no longer active. **Tire Learning Active** in the Driver Information Center goes out.
12. Turn the ignition off.
13. Set all four tires to the recommended air pressure level as indicated on the tire-loading information label.
14. Put the valve caps back on the valve stems.

Removing a tire

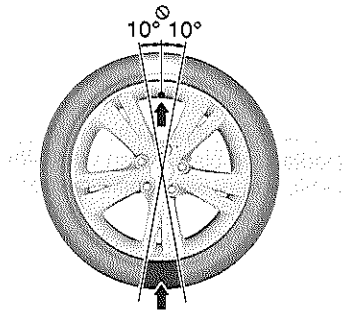

Remove the tire with a tire machine. It is important to follow the instructions for the tire machine.

- Do not fit the tire tool in an area $\pm 10^\circ$ from the valve.
- Start removing opposite the valve.
- Remove the rear side first.

Fitting a tire

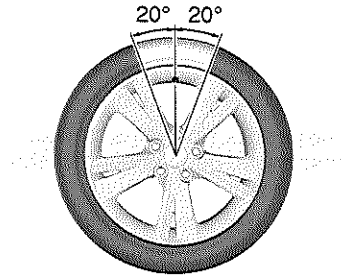

Fit the tire with a tire machine. It is important to follow the instructions for the tire machine.

- Start to fit about 20° after the valve.
- Finish fitting before an area 20° from the valve.
- Do not inflate the tire to a pressure higher than 102 psi.

Tread Depth

Notice

Make sure you are familiar with the legal limit for minimum tread depth in your country and also any regulations governing the use of winter (snow) tires.

Check tread depth at regular intervals.

Tires should be replaced for safety reasons at a tread depth of 0.08-0.1 inches (0.16 inches for winter tires).

If there is more wear at the front than the rear, swap round front wheels and rear wheels. Ensure that the direction of rotation of the wheels is the same as before.

Tires age, even if they are not used. We recommend tire replacement every 6 years.

Treadwear indicators

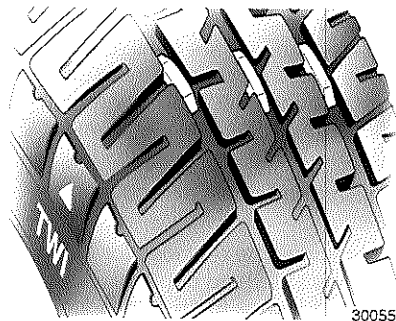

The tires incorporate wear indicators in the form of smooth, treadless strips across the width, which become visible when only 2/32 inches of tread remains. As soon as the indicators become visible, new tires should be fitted without delay.

When it is time for new tires

One way to tell when it's time for new tires is to check the treadwear indicators, which will appear when your tires have only 1/16 inch or less of tread remaining.

You need a new tire if any of the following statements are true:

- You can see the indicators at three or more places around the tire.
- You can see cord or fabric showing through the tire's rubber.
- The tread or sidewall is cracked, cut or snagged deep enough to show cord or fabric.
- The tire has a bump, bulge or split.
- The tire has a puncture, cut or other damage that can't be repaired well because of the size or location of the damage.

Buying new tires

⚠Warning

Mixing tires could cause you to lose control while driving. If you mix tires of different sizes or types (radial and bias-belted tires), the vehicle may not handle properly, and you could have a collision. Using tires of different sizes may also cause damage to your vehicle. Be sure to use tires of the same size and type on all wheels. It is OK to drive with your compact spare temporarily. It was developed for use on your vehicle.

⚠Warning

If you use bias-ply tires on your vehicle, the wheel rim flanges could develop cracks after many miles of driving. A tire and/or wheel could fail suddenly, causing a collision. Use only radial-ply tires with the wheels on your vehicle.

Notice

Wide wheels and tires with side walls that are too low can:

- Be damaged in potholes, etc.
- Cause springs, shock absorbers and wheel bearings and body mountings to be overloaded.
- Affect the function of the ESP®.
- The speed and load limits of the tires must not be exceeded.

To find out what kind and size of tires you need, look at the tire-loading information label.

Before changing to wheels/tires of another size, we recommend that you contact an authorized Saab workshop regarding acceptable options.

Wheel/tire combinations that are not approved by Saab can negatively affect the car's directional stability, steering and braking in both wet and dry conditions.

The wheels and tires have been carefully matched to the characteristics of the car and play a key role in its outstanding road holding and handling.

Do not take it for granted that a wheel/tire combination will work in the best possible way, just because it can be fitted to the car.

To ensure that the speedometer is as accurate as possible it should be re-programmed if wheels of a different dimension are fitted. Contact a Saab dealer.

Because of front wheel drive, the front tires tend to wear faster than the rear ones. New tires should always be fitted in pairs, so that tires on the same axle have the same amount of tread.

Store wheels lying flat or hanging - **never** standing upright.

Wheel alignment and tire balance

The wheels on your vehicle were aligned and balanced carefully at the factory to give you the longest tire life and best overall performance.

Scheduled wheel alignment and wheel balancing are not required. However, if you notice unusual tire wear or your vehicle pulling one way or the other, the alignment may need

to be reset. If you notice your vehicle vibrating when driving on a smooth road, your wheels may need to be re-balanced.

Wheel Replacement

⚠ Warning

Using the wrong replacement wheels, wheel bolts or wheel nuts on your vehicle can be dangerous. It could affect the braking and handling of your vehicle, make your tires lose air and make you lose control. You could have a collision in which you or others could be injured. Always use the correct wheel, wheel bolts and wheel nuts for replacement.

⚠ Warning

If mounting just one new pair of tires, they should be mounted on the rear wheels because these are more critical to the directional stability of the car (e.g. when braking or in a skid). The existing rear wheels should therefore be moved to the front.

⚠ Warning

Putting a used wheel on your vehicle is dangerous. You have no way of knowing how it has been used or how far it has been driven. It could fail suddenly and cause a collision. If you have to replace a wheel, use a new GM original equipment wheel.

Notice

The wrong wheel could also cause problems with bearing life, brake cooling, speedometer or odometer calibration, headlamp aim, bumper height, vehicle ground clearance and tire or tire chain clearance to the body and chassis.

Replace any wheel that is bent, cracked or badly rusted or corroded. If wheel nuts keep coming loose, the wheel, wheel bolts and wheel nuts should be replaced. If the wheel leaks air, replace it (except some aluminum wheels, which can sometimes be repaired). See your dealer if any of these conditions exist.

Your dealer will know the kind of wheel you need.

Each new wheel should have the same load-carrying capacity, diameter, width, offset and be mounted the same way as the one it replaces.

If you need to replace any of your wheels, wheel bolts or wheel nuts, replace them only with new Saab original equipment parts. This way, you

will be sure to have the right wheel, wheel bolts and wheel nuts for your vehicle.

Different Size Tires and Wheels

If tires of a different size than those fitted at the factory are used, it may be necessary to reprogram the speedometer as well as the nominal tire pressure and make other vehicle modifications.

After converting to a different tire size, have the label with tire pressures replaced.

⚠ Warning

Use of unsuitable tires or wheels may lead to accidents and will invalidate the vehicle type approval.

Wheel Covers

Wheel covers and tires that are factory approved for the respective vehicle and comply with all of the relevant wheel and tire combination requirements must be used.

If the wheel covers and tires used are not factory approved, the tires must not have a rim protection ridge.

Wheel covers must not impair brake cooling.

⚠Warning

Use of unsuitable tires or wheel covers could lead to sudden pressure loss and thereby accidents.

Tire Chains

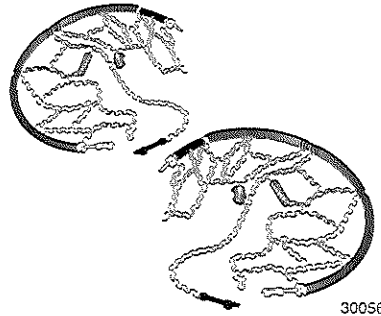

⚠Warning

Tire chains are only permitted on the front wheels with tire sizes 225/50 R 17 and 235/45 R 18.

Tire chains used on a vehicle without the proper amount of clearance could cause damage to the brakes, suspension or other vehicle parts. The damage caused by the tire chains could cause you to lose control of your vehicle and you or others could be injured in a collision.

Use another type of traction device only if its manufacturer recommends it for use on your vehicle and tire size combination and the road conditions. Follow that manufacturer's instructions. To help avoid damage to your vehicle, drive slowly, readjust or remove the device if it is in contact with your vehicle, and do not spin your wheels.

If you find traction devices that will fit, install them on the front tires.

Always use fine mesh chains that add no more than 0.4 inches to the tire tread and the inboard sides (including chain lock).

Damage could lead to tire blowout.

The use of tire chains is not permitted on the temporary spare wheel.

Notice

Contact your Saab dealer regarding suitable snow chains. Install them on the front tires and tighten them as tightly as possible with the ends securely fastened. Drive slowly and follow the chain manufacturer's instructions. If you can hear the chains making contact with your vehicle, stop and retighten them. If the contact continues, slow down until it stops. Driving too fast or spinning the wheels with chains on will damage your vehicle.

Tire Repair Kit

Minor damage to the tire tread or sidewall can be repaired with the tire repair kit.

Do not remove foreign bodies from the tires.

Tire damage exceeding 0.16 inches or that is at the tire's sidewall near the rim cannot be repaired with the tire repair kit.

Warning

Do not drive faster than 50 mph.
Do not use for a lengthy period.
Steering and handling may be affected.

If you have a flat tire:
Apply the parking brake and engage first gear, reverse gear or P.

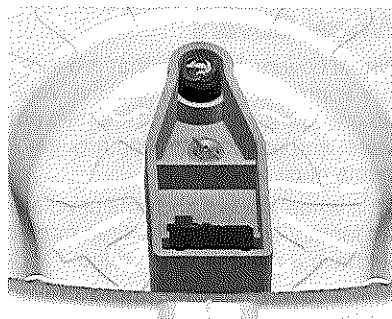

The tire repair kit is in a compartment under the floor cover in the trunk.

1. Take the tire repair kit from the compartment.
2. Remove the compressor.

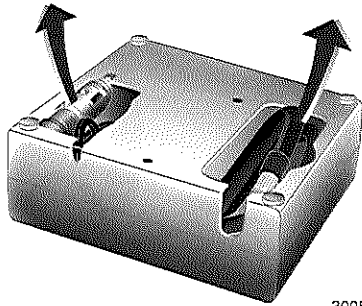

30057

3. Remove the electrical connection cable and air hose from the storage compartments on the underside of the compressor.

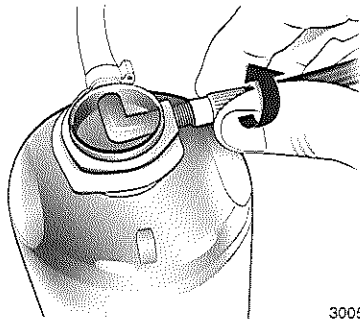

30058

4. Screw the compressor air hose to the connection on the sealant bottle.
5. Fit the sealant bottle into the retainer on the compressor.
Set the compressor near the tire in such a way that the sealant bottle is upright.

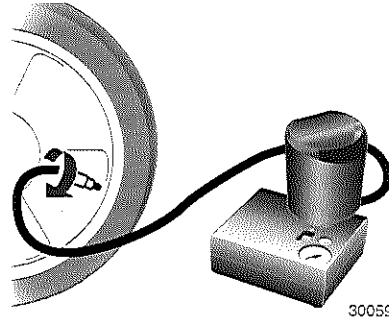

30059

6. Unscrew valve cap from defective tire.
7. Screw the filler hose to the tire valve.
8. The switch on the compressor must be set to O.

9. Connect the compressor plug to the power outlet socket.
To avoid discharging the battery, we recommend running the engine.

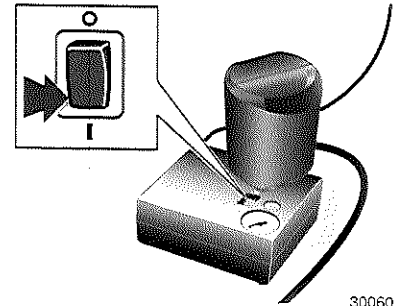

30060

10. Set the rocker switch on the compressor to I. The tire is filled with sealant.
11. The compressor pressure gauge briefly indicates up to 87 psi while the sealant bottle is emptying (approx. 30 seconds). Then the pressure starts to drop.
12. All of the sealant is pumped into the tire. Then the tire is inflated.

13. The prescribed tire pressure should be obtained within 10 minutes. When the correct pressure is obtained, switch off the compressor.

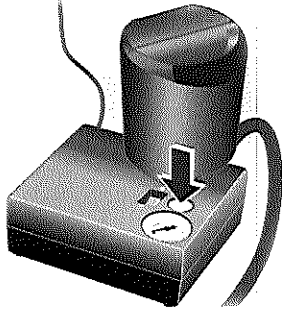

30061

If the prescribed tire pressure is not obtained within 10 minutes, remove the tire repair kit. Move the vehicle one tire rotation. Reattach the tire repair kit and continue the filling procedure for 10 minutes. If the prescribed tire pressure is still not obtained, the tire is too badly damaged. Seek the assistance of a workshop.

Drain excess tire pressure with the button over the pressure indicator.

Do not run the compressor longer than 10 minutes.

14. Detach the tire repair kit. Push catch on bracket to remove sealant bottle from bracket. Screw tire inflation hose to the free connection of sealant bottle. This prevents sealant from escaping. Stow tire repair kit in trunk.
15. Remove any excess sealant using a cloth.
16. Take the label indicating maximum permitted speed from the sealant bottle and affix in the driver's field of view.
17. Continue driving immediately so that sealant is evenly distributed in the tire. After driving approx. 6 miles (but no more than 10 minutes), stop and check tire pressure. Screw compressor air hose directly onto tire valve and compressor when doing this.

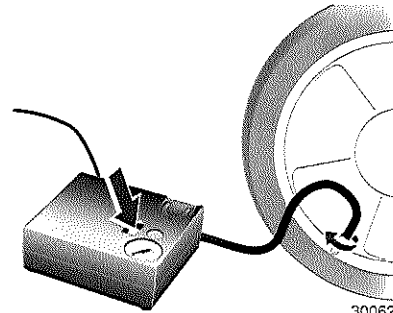

30062

If tire pressure is more than 19 psi, set it to the correct value. Repeat the procedure until there is no more loss of pressure.

If the tire pressure has fallen below 19 psi, the vehicle must not be used. Seek the assistance of a workshop.

18. Stow away tire repair kit in trunk.

Notice

The driving comfort of the repaired tire is severely affected. The tire must therefore be replaced. If there is unusual noise or the compressor becomes hot, turn the compressor off for at least 30 minutes. The built-in safety valve opens at a pressure of 102 psi. The sealant can only be stored for approximately 4 years, after which time its sealing capability is no longer guaranteed. Pay attention to the storage information on the sealant bottle. Replace the used sealant bottle. Dispose of the bottle as prescribed by applicable laws. The compressor and sealant can be used from approx. -22° F. The adapters supplied can be used to pump up other items, e.g. footballs, air mattresses, inflatable dinghies, etc.

Tire Changing**Removing the spare wheel and tools**

The equipment you need is located in the trunk.

1. Open the trunk.
2. Turn the wing nut anti-clockwise and remove the spare tire.
3. Place the spare tire next to the tire being changed.
4. The jack and tools are stored below the spare tire. Remove them from their container and place them near the tire being changed.

Removing the flat tire and installing the

1. Do a safety check before proceeding.
2. Turn the wheel wrench anti-clockwise to loosen and remove the wheel nut caps.

If needed, finish loosening them by hand. The nut caps will not come off of the wheel cover.

The edge of the wheel cover could be sharp, so do not try to remove the cover with your bare hands. Do not drop the cap or lay it face down, as it could become scratched or damaged.

Store the wheel cover in the trunk until you have the flat tire repaired or replaced.

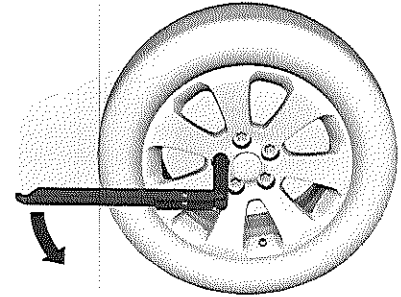

3. Turn the wheel wrench anti-clockwise to loosen all the wheel nuts, but do not remove them yet.

Notice

Make sure that the jack lifting head is in the correct position or you could damage your vehicle. The repairs would not be covered by your warranty.

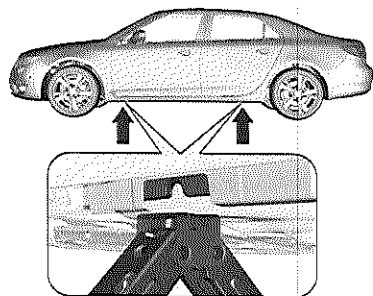

4. Position the jack head, as shown. Set the jack to the necessary height before positioning it below the jacking point.

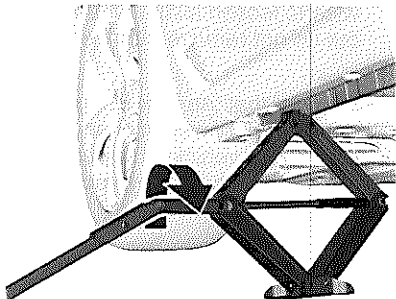

5. Attach jack handle and with the jack correctly aligned rotate handle until wheel is clear of the ground.

Warning

Getting under a vehicle when it is jacked up is dangerous. If the vehicle slips off the jack, you could be badly injured or killed. Never get under a vehicle when it is supported only by a jack.

Warning

Raising your vehicle with the jack improperly positioned could damage the vehicle or even make the vehicle fall. To help avoid personal injury and vehicle damage, be sure to fit the jack lifting head in the proper position before raising the vehicle.

Warning

Lifting a vehicle and getting under it to do maintenance or repairs is dangerous without the appropriate safety equipment and training. If a jack is provided with the vehicle, it is designed only for changing a flat tire. If it is used for anything else, you or others could be badly injured or killed if the vehicle slips off the jack. If a jack is provided with the vehicle, only use it for changing a flat tire.

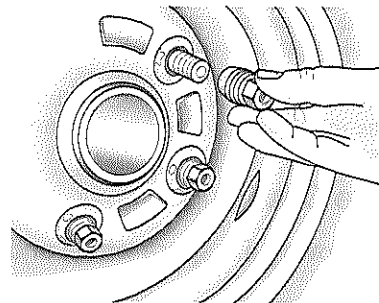

6. Remove all of the wheel nuts.

7. Remove the flat tire.

⚠ Warning

Rust or dirt on a wheel or on the parts to which it is fastened could make wheel nuts loosen over time. The wheel could come off and cause an accident. When changing a wheel, remove any rust or dirt from places where the wheel attaches to the vehicle. In an emergency, use a cloth or a paper towel to do this; but be sure to use a scraper or wire brush later, if needed, to get all the rust or dirt off.

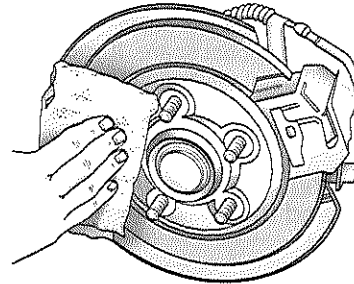

8. Remove any rust or dirt from the wheel bolts, mounting surfaces, and full-size spare tire.
9. Install the compact full-size spare tire.

⚠ Warning

Never use oil or grease on bolts or nuts because the nuts might come loose. The vehicle's wheel could fall off, causing a collision.

10. Put the wheel nuts back on with the rounded end of the nuts toward the wheel. Turn each nut clockwise by hand until the wheel is held against the hub.
11. Lower the vehicle by turning the jack handle anti-clockwise. Lower the jack completely.

⚠ Warning

Wheel nuts that are improperly or incorrectly tightened can cause the wheels to become loose or come off. The wheel nuts should be tightened with a torque wrench to the proper torque specification after replacement. Follow the torque specification supplied by the aftermarket manufacturer when using the locking wheel nuts accessory.

Notice

Improperly tightened wheel nuts can lead to brake pulsation and rotor damage. To avoid expensive brake repairs, evenly tighten the wheel nuts in the proper sequence and to the proper torque specification.

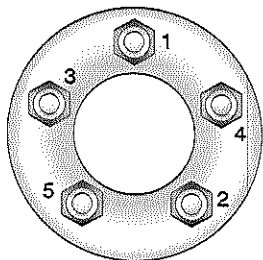

12. Tighten the wheel nuts firmly in a crisscross sequence, as shown.
13. Lower the jack all the way and remove the jack from under the vehicle.
14. Tighten the wheel nuts firmly with the wheel wrench. Tightening torque is 111 lb-ft.

Notice

Wheel covers will not fit on your vehicle's compact spare. If you try to put a wheel cover on the compact spare, the cover or the spare could be damaged.

Storing a flat or a full-size spare tire and tools**⚠ Warning**

Storing a jack, a tire, or other equipment in the passenger compartment of the vehicle could cause injury. In a sudden stop or collision, loose equipment could strike someone. Store all of these in the proper place.

To store the flat or spare tire and tools:

1. Place the jack and tools in the rear trunk.
2. Place the flat or spare tire in the storage compartment below the floor covering.

Secure it with the wing nut.

If the wheel is larger than the spare, place the floor cover on the projecting wheel.

The compact spare is for temporary use only. Replace the compact spare tire with a full-size tire as soon as you can.

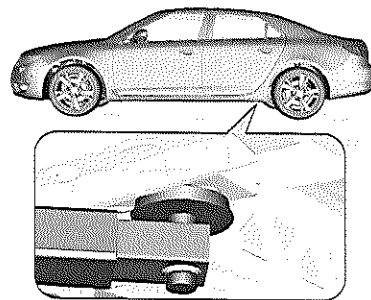
Jacking position for lifting platform

Rear arm position of the lifting platform at the underbody.

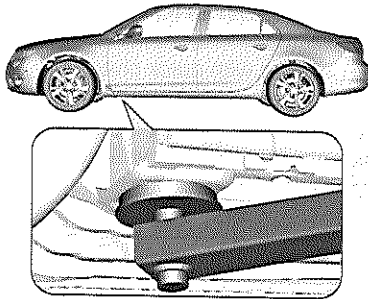

Front arm position of the lifting platform at the underbody.

Full-Size Spare Tire

Some vehicles are equipped with a tire repair kit instead of a spare wheel.

The spare wheel can be classified as a temporary spare wheel depending on its size compared to the other mounted wheels and country regulations.

The spare wheel has a steel rim.

Use of a spare wheel that is smaller than the other wheels or together with winter tires could affect driveability. Have the defective tire replaced as soon as possible.

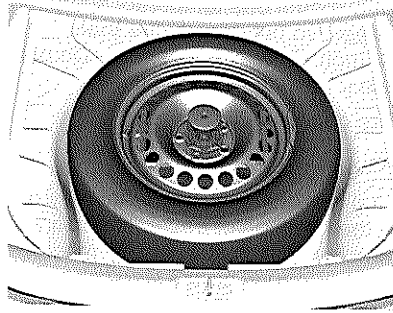

The spare wheel is located in the trunk beneath the floor covering. It is secured in the recess with a wing nut.

Storing the replaced wheel in the trunk

The spare wheel well is not designed for all permitted tire sizes. If a wheel wider than the spare must be stowed

in the spare wheel well, the thread bolt for mounting the wheel must be replaced by a longer one.

- Remove temporary spare wheel after turning the wing nut anti-clockwise.
- Remove tool box and wheel nut wrench from spare wheel well.
- Move the bolt sideways out of the adapter on the floor.

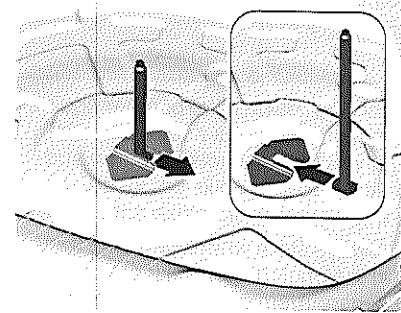

- Insert the longer thread bolt from the tool box into the adapter on the floor ⇨ 189.

- Put the wheel nut wrench bag and tool box back in the spare wheel well.
- Store the wheel with the outside upturned and secure by turning the wing nut clockwise.

The floor cover can be placed on the projecting wheel.

To fit the spare wheel in the well after renewing the defective wheel, use the short thread bolt again.

⚠ Warning

Storing a jack, a tire or other equipment in the trunk could cause injury if they are not fixed. In a sudden stop or a collision, loose equipment could strike someone.

Always store wheel, jack and tools in the original storage location and secure them with a fixing device.

Always place the flat tire in the spare wheel well and secure it by turning the wing nut clockwise.

Temporary spare wheel

Use of the temporary spare wheel could affect driveability. Have the defective tire renewed or repaired as soon as possible.

Only mount one temporary spare wheel. Do not drive faster than 50 mph. Take curves slowly. Do not use for a long period of time.

Tire chains ⇨ 207.

Directional tires

Fit directional tires such that they roll in the direction of travel. The rolling direction is indicated by a symbol (e.g. an arrow) on the sidewall.

The following applies to tires fitted opposing the rolling direction:

- Driveability may be affected. Have the defective tire renewed or repaired as soon as possible.
- Do not drive faster than 50 mph.
- Drive particularly carefully on wet and snow-covered road surfaces.

Jump Starting

Do not start with quick charger.

A vehicle with a discharged battery can be started using jump leads and the battery of another vehicle.

⚠ Warning

Be extremely careful when jump starting. Any deviation from the following instructions can lead to injuries or damage caused by battery explosion or damage to the electrical systems of both vehicles.

⚠ Warning

Avoid contact with eyes, skin, fabrics and painted surfaces. The fluid contains sulphuric acid which can cause injuries and damage in the event of direct contact.

- Never expose the battery to naked flames or sparks.

- A discharged battery can already freeze at a temperature of 32° F. Defrost the frozen battery before connecting jump leads.
- Wear eye protection and protective clothing when handling a battery.
- Use a booster battery with the same voltage (12 Volts). Its capacity (Ah) must not be much less than that of the discharged battery.
- Use jump leads with insulated terminals and a cross section of at least 0.6 inch².
- Do not disconnect the discharged battery from the vehicle.
- Switch off all unnecessary electrical consumers.
- Do not lean over the battery during jump starting.
- Do not allow the terminals of one lead to touch those of the other lead.
- The vehicles must not come into contact with each other during the jump starting process.
- Apply the parking brake, automatic transmissions to P.

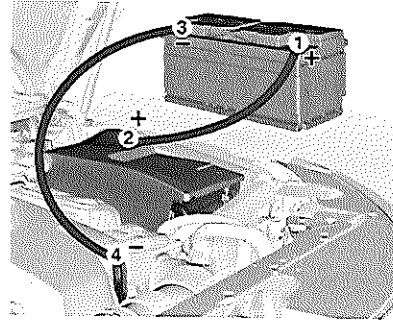

Lead connection order:

1. Connect the red lead to the positive terminal of the booster battery.
2. Connect the other end of the red lead to the positive terminal of the discharged battery.
3. Connect the black lead to the negative terminal of the booster battery.
4. Connect the other end of the black lead to a vehicle grounding point, such as the engine block or an en-

gine mounting bolt. Connect as far away from the discharged battery as possible, however at least 2 ft.

Route the leads so that they cannot catch on rotating parts in the engine compartment.

To start the engine:

1. Start the engine of the vehicle providing the jump.
2. After 5 minutes, start the other engine. Start attempts should be made for no longer than 15 seconds at an interval of 1 minute.
3. Allow both engines to idle for approx. 3 minutes with the leads connected.
4. Switch on electrical consumers (e.g. headlights, heated rear window) of the vehicle receiving the jump start.
5. Reverse above sequence exactly when removing leads.

Towing

Towing the Vehicle

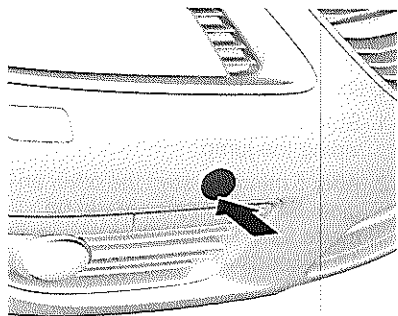

Disengage cap at bottom and remove downwards.

The towing eye is stowed with the vehicle tools ↻ 189.

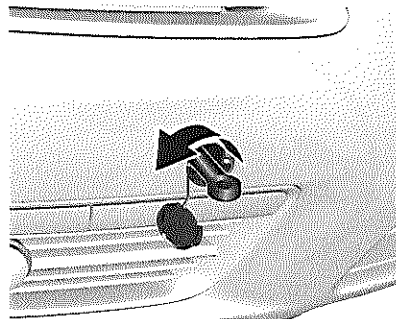

Screw in the towing eye as far as it will go until it stops in a horizontal position.

Attach a tow rope - or better still a tow rod - to the towing eye.

The towing eye must only be used for towing and not for recovering the vehicle.

Switch on ignition to permit operation of stop lights, horn and windshield wiper.

Transmission in neutral.

Caution

Drive slowly. Do not drive jerkily. Excessive tractive force can damage the vehicle.

When the engine is not running, considerably more force is needed to brake and steer.

To prevent the entry of exhaust gases from the towing vehicle, switch on the air recirculation and close the windows.

Vehicles with automatic transmission and Cross-wheel drive: The vehicle must be towed facing forward. If the vehicle is towed with all four wheels on the ground, the maximum speed is 50 mph and for a maximum of 62 miles. If the front axle has been raised, the maximum speed is 30 mph. There is no distance limitation.

Seek the assistance of a workshop. After towing, unscrew the towing eye.

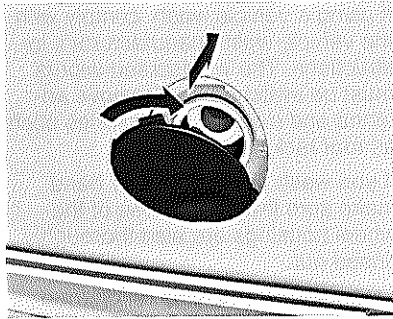

Insert cap below, turn slightly clockwise and close cap.

Towing Another Vehicle

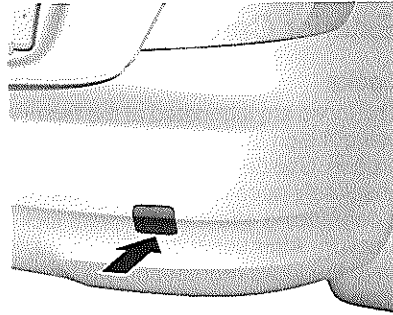

Disengage cap at bottom and remove downwards.

The towing eye is stowed with the vehicle tools ↻ 189.

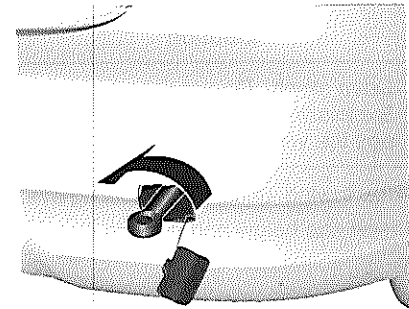

Screw in the towing eye as far as it will go until it stops in a horizontal position.

The lashing eye at the rear underneath the vehicle must never be used as a towing eye.

Attach a tow rope - or better still a tow rod - to the towing eye.

The towing eye must only be used for towing and not for recovering a vehicle.

Caution

Drive slowly. Do not drive jerkily. Excessive tractive force can damage the vehicle.

After towing, unscrew the towing eye. Insert cap below and engage it.

Appearance Care**Exterior Care****Locks**

The locks are lubricated at the factory using a high quality lock cylinder grease. Use de-icing agent only when absolutely necessary, as this has a degreasing effect and impairs lock function. After using de-icing agent, have the locks regreased by a workshop.

Washing

The paintwork of your vehicle is exposed to environmental influences. Wash and wax your vehicle regularly. When using automatic vehicle washes, select a program that includes waxing.

Bird droppings, dead insects, resin, pollen and the like should be cleaned off immediately, as they contain aggressive constituents which can cause paint damage.

If using a vehicle wash, comply with the vehicle wash manufacturer's instructions. The windscreen wipers must be switched off. Remove antenna and external accessories such as roof racks etc.

If you wash your vehicle by hand, make sure that the insides of the wheel housings are also thoroughly rinsed out.

Clean edges and folds on opened doors and the hood as well as the areas they cover.

Have the door hinges of all doors greased by a workshop.

Do not clean the engine compartment with a steam-jet or high-pressure jet cleaner.

Thoroughly rinse and leather-off the vehicle. Rinse leather frequently. Use separate leathers for painted and glass surfaces: remnants of wax on the windows will impair vision.

Do not use hard objects to remove spots of tar. Use tar removal spray on painted surfaces.

Exterior lights

Headlamps, rear lights and other light covers are made of plastic. Only use liquid detergent when cleaning the plastic lenses. Do not use mechanical cleaning, any abrasive or caustic agents, do not use an ice scraper, and do not clean them dry. Rinse off the detergent immediately, otherwise cracks may form in the plastic lenses.

Polishing and waxing

Wax the vehicle regularly (at the latest when water no longer beads). Otherwise, the paintwork will dry out. Polishing is necessary only if the paint has become dull or if solid deposits have become attached to it.

Paintwork polish with silicone forms a protective film, making waxing unnecessary.

Plastic body parts must not be treated with wax or polishing agents.

Windows and windscreen wiper blades

Use a soft lint-free cloth or chamois leather together with window cleaner and insect remover.

When cleaning the rear window, make sure the heating element inside is not damaged.

For mechanical removal of ice, use a sharp-edged ice scraper. Press the scraper firmly against the glass so that no dirt can get under it and scratch the glass.

Clean smearing wiper blades with a soft cloth and window cleaner.

Wheels and tires

Do not use high-pressure jet cleaners.

Clean rims with a pH-neutral wheel cleaner.

Rims are painted and can be treated with the same agents as the body.

Paintwork damage

Rectify minor paintwork damage with a touch-up pen before rust forms. Have more extensive damage or rust areas repaired by a workshop.

Underbody

Some areas of the vehicle underbody have a PVC undercoating while other critical areas have a durable protective wax coating.

After the underbody is washed, check the underbody and have it waxed if necessary.

Bitumen/rubber materials could damage the PVC coating. Have underbody work carried out by a workshop.

Before and after winter, wash the underbody and have the protective wax coating checked.

Towing equipment

Do not clean the coupling ball bar with a steam-jet or high-pressure jet cleaner.

Interior Care

Interior and upholstery

Only clean the vehicle interior, including the instrument panel fascia and panelling, with a dry cloth or interior cleaner.

The instrument panel should only be cleaned using a soft damp cloth.

Clean fabric upholstery with a vacuum cleaner and brush. Remove stains with an upholstery cleaner.

Clean safety belts with lukewarm water or interior cleaner.

Caution

Close Velcro fasteners as open Velcro fasteners on clothing could damage seat upholstery.

The same applies to clothing with sharp-edged objects, like zips or belts or studded jeans.

Plastic and rubber parts

Plastic and rubber parts can be cleaned with the same cleaner as used to clean the body. Use interior cleaner if necessary. Do not use any other agent. Avoid solvents and gasoline in particular. Do not use high-pressure jet cleaners.

Care of the Head-up Display, Driver Information Center and Infotainment Display

Clean the inside of the windshield as needed to remove any dirt or film that could reduce the sharpness or clarity of the HUD image.

To clean the HUD lens and the displays, use a soft, clean cloth that has household glass cleaner or alcohol sprayed on it. Wipe the HUD lens and the displays gently, then dry it. Do not spray cleaner directly on the lens or the displays because the cleaner could leak into the unit.

If the panel or the displays are dusty, wipe them with a dry, soft cloth.

Do not wipe the panel with a hard cloth or use a volatile liquid such as thinner, it could scratch the surface or erase the characters on the buttons.

Caution

Never use abrasive cleaners when cleaning glass surfaces, you would scratch the glass.

Service and Maintenance

General Information	223
Recommended Fluids, Lubricants, and Parts	224

General Information

Service Information

Your car comes with a display which shows you when a service is due. The time at which this message appears is first of all based on driving conditions, such as cold starts, stop and go, towing, hill driving and a lot of idling. The distance traveled and the elapsed time since the last service set the limit between service occasions. As a result, the intervals between services may vary considerably depending on how you drive and on external conditions. In order to ensure economical and safe vehicle operation and to maintain the value of your vehicle, it is of vital importance that all maintenance work is carried out at the proper intervals as specified. The detailed, up-to-date service schedule for your vehicle is covered in the Service and Warranty Booklet.

Service display ↪ 95.

Service intervals

The maximum interval between service occasions is 10,000 miles or 1 year, whichever comes first.

Confirmations

Confirmation of service is recorded in the Service and Warranty Booklet. The date and mileage is completed with the stamp and signature of the servicing workshop.

Make sure that the Service and Warranty Booklet is completed correctly as continuous proof of service is essential if any warranty or goodwill claims are to be met, and is also a benefit when selling the vehicle.

Recommended Fluids, Lubricants, and Parts

Recommended Fluids and Lubricants

Only use products that have been tested and approved. Damage resulting from the use of non-approved materials will not be covered by the warranty.

Warning

Operating materials are hazardous and could be poisonous. Handle with care. Pay attention to information given on the containers.

Engine oil

Engine oil is identified by its quality and its viscosity. Quality is more important than viscosity when selecting which engine oil to use. The oil quality ensures engine cleanliness, wear protection and oil aging control, whereas viscosity grade gives information on the oil's thickness over a temperature range.

Engine oil quality

Synthetic oil meeting standard GM4718M.

This vehicle's engine requires a special oil meeting GM4718M. Oils meeting this standard may be identified as synthetic. However, not all synthetic oils will meet this standard. Use only an oil that meets standard GM4718M.

American Petroleum Institute (API) starburst symbol:



Oils meeting these requirements should have the starburst symbol on the container. This symbol indicates that the oil has been certified by the American Petroleum Institute (API).

This vehicle's engine was filled at the factory with a synthetic 5W-30 oil meeting the GM4718M specifications.

Topping up engine oil

Engine oils of different manufacturers and brands can be mixed as long as they comply with the required engine oil quality and viscosity.

Use of engine oil not meeting the required specifications can cause long-term engine damage under certain operating conditions.

Additional engine oil additives

The use of additional engine oil additives could cause damage and invalidate the warranty.

Engine oil viscosity grades

Use only engine oil viscosity grades SAE 5W-30 or 5W-40, 0W-30 or 0W-40.

The SAE viscosity grade gives information of the thickness of the oil.

Multigrade oil is indicated by two figures. The first figure, followed by a W, indicates the low temperature viscosity and the second figure the high temperature viscosity.

Select the appropriate viscosity grade depending on the minimum ambient temperature. All of the recommended viscosity grades are suitable for high ambient temperatures.

- down to -13° F:
SAE 5W-30 or SAE 5W-40
- below -13° F:
SAE 0W-30 or SAE 0W-40

Coolant and antifreeze

Use only silicate-free long life coolant (LLC) antifreeze.

The system is factory filled with coolant designed for excellent corrosion protection and frost protection down to approx. - 18° F. This concentration should be maintained all year round. The use of additional coolant additives that intend to give additional cor-

rosion protection or seal against minor leaks can cause function problems. Liability for consequences resulting from the use of additional coolant additives will be rejected.

Brake fluid

Only use high-performance brake fluid DOT 4 approved for the vehicle, consult your workshop.

Over time, brake fluid absorbs moisture which will reduce braking effectiveness. The brake fluid should therefore be replaced at the specified interval.

Brake fluid should be stored in a sealed container to avoid water absorption.

Ensure brake fluid does not become contaminated.

Power steering fluid

Use only Dextron VI, consult your workshop.

Technical Data

Vehicle Identification 226

Vehicle Data 228

Vehicle Identification

Vehicle Identification Number (VIN)

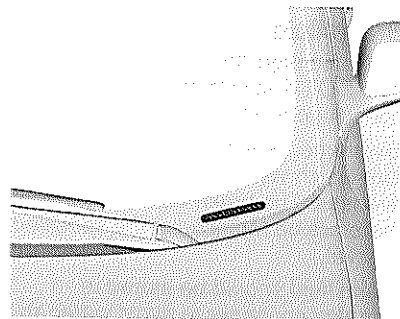

The Vehicle Identification Number is visible through the windshield.

Identification Plate

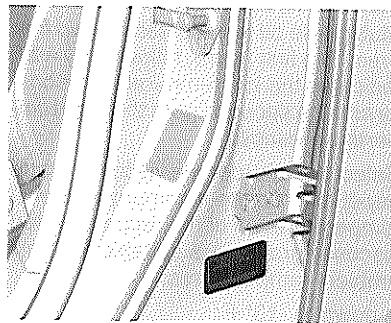

The identification label is located on the front left door frame.

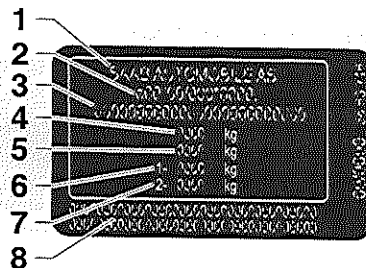

Information on identification plate:

- 1 = Manufacturer
- 2 = Type approval number
- 3 = Vehicle Identification Number
- 4 = Permissible gross vehicle weight rating
- 5 = Permissible gross train weight
- 6 = Maximum permissible front axle load
- 7 = Maximum permissible rear axle load
- 8 = Vehicle-specific or country specific data

The combined total of front and rear axle loads must not exceed the permissible gross vehicle weight. For example, if the front axle is bearing its maximum permissible load, the rear axle can only bear a load that is equal to the gross vehicle weight minus the front axle load.

The technical data is determined in accordance with European Community standards. We reserve the right to make modifications. Specifications in the vehicle documents always have priority over those given in this manual.

Vehicle Data
Engine Data

Sales designation	Turbo6
Engine identifier code	A28NER
Number of cylinders	6
Piston displacement [cu.in.]	170
Engine power [HP]	300
at rpm	5300
Torque [ft.lb.]	295
at rpm	2000 - 4500
Fuel type	Gasoline
Octane rating AON	
recommended	93
optional	91
optional	87 ¹⁾

¹⁾ Possible only if high engine load, full load or driving in mountainous terrain is avoided.

Vehicle Weight

Curb weight

(i.e. with full fuel tank, full washer fluid reservoir, standard tools and spare wheel)

Saab 9-5 Turbo6 Sedan

	Total	Front	Rear
Standard option [lbs]	4250	2480	1770
Heaviest option [lbs]	4350	2510	1850

Gross vehicle weight (GVW)

Saab 9-5 Turbo6 Sedan

	GVW Total	GVW Front axle	GVW Rear axle
Standard option [lbs]	5190	2870	2670
Heaviest option [lbs]	5290	2870	2670

230 Technical Data

Combined weight of occupants and cargo

Saab 9-5 Turbo6 Sedan

	Occupants weight ²⁾	Cargo load	Vehicle capacity weight
Standard option [lbs]	750 (5x150 lbs)	176	926
Heaviest option [lbs]	750 (5x150 lbs)	176	926

Vehicle Dimensions

	Sedan 4-door
Length [inches]	197
Width without exterior mirrors [inches]	74
Width with two exterior mirrors [inches]	83
Height (without antenna) [inches]	58
Length of trunk floor [inches]	44
Length of trunk with folded rear seats [inches]	77
Trunk width [inches]	41

²⁾ 150 lbs per passenger

	Sedan 4-door
Trunk height [inches]	19
Wheelbase [inches]	112
Turning circle diameter [ft]	39

Capacities and Specifications

Engine oil

Engine	A28NER
including Filter [qts.]	6.6
between MIN and MAX [qts.]	1.06

Fuel tank

Gasoline, nominal capacity [gal.]	18.5
-----------------------------------	------

Tire Pressure

Tire pressures for vehicles with cross-wheel drive

Sedan

Engine	Tires	Comfort with up to 3 people		ECO with up to 3 people		With full load	
		front [kPa/bar] ([psi])	rear [kPa/bar] ([psi])	front [kPa/bar] ([psi])	rear [kPa/bar] ([psi])	front [kPa/bar] ([psi])	rear [kPa/bar] ([psi])
A28NER	225/50 R17, 235/45 R18	270/2.7 (39)	270/2.7 (39)	-	-	280/2.8 (41)	320/3.2 (46)
	225/55 R17	280/2.8 (41)	280/2.8 (41)	300/3.0 (43)	300/3.0 (43)	280/2.8 (41)	330/3.3 (47)
	245/45 R18, 245/40 R18	280/2.8 (41)	280/2.8 (41)	310/3.1 (45)	310/3.1 (45)	290/2.9 (41)	330/3.3 (47)
	245/40 R19	260/2.6 (38)	260/2.6 (38)	310/3.1 (45)	310/3.1 (45)	280/2.8 (41)	310/3.1 (45)
	Temporary spare wheel	420/4.2 (61)	420/4.2 (61)	-	-	420/4.2 (61)	420/4.2 (61)

Customer Information

Customer Information	233
Reporting Safety Defects	234
Vehicle Data Recording and Privacy	234

Customer Information

Customer Assistance Offices

Warranties and service problem assistance

For complete information about all applicable warranties, including the New Car Warranty, Perforation Warranty, Vehicle Emission Warranty and Emission Perforation Warranty, consult the Warranties and Service Record Booklet which accompanies this Owner's Manual. It also contains owner assistance information including Saab Roadside Assistance. If the booklet is lost or misplaced, a new one may be ordered through a Saab dealer or by contacting Saab.

In the U.S. there is a national Customer Assistance Center at Saab Cars North America, Inc. The toll-free number to call from all 50 states is 1-800-955-9007.

A list of authorized Saab sales and service dealers is available for those planning to travel to Canada.

Travelers may call the Customer Assistance Center in the country in which they are traveling.

Change of Address Notification

Two change of address cards are provided at the end of the Saab Warranty and Service Book. Knowing your current address allows Saab to contact you in the event of a recall or service campaign. Please help us keep our records up to date for your own peace of mind.

Reporting Safety Defects

Reporting Safety Defects to the United States Government

If you believe that your vehicle has a defect which could cause a crash or could cause injury or death, you should immediately inform the National Highway Traffic Safety Administration (NHTSA) in addition to notifying Saab Cars North America, Inc.

If NHTSA receives similar complaints, it may open an investigation, and if it finds that a safety defect exists in a group of vehicles, it may order a recall and remedy campaign. However, NHTSA cannot become involved in individual problems between you, your dealer, or Saab Cars North America, Inc..

To contact NHTSA, you may call the toll-free Vehicle Safety Hotline at 1-888-327-4236 (TTY: 1-800-424-9153; go to <http://www.safercar.gov>; or write to: Admin-

istrator, NHTSA, 1200 New Jersey Ave., SE., Washington D.C. 20590. You can also obtain other information about motor vehicle safety from <http://www.safercar.gov>.

Vehicle Data Recording and Privacy

Event Data Recorders

The vehicle has a number of sophisticated systems that monitor and control several vehicle data. Some data may be stored during regular operation to facilitate repair of detected malfunctions, other data is stored only in a crash or near crash event by systems commonly called event data recorders (EDR).

The systems may record data about the condition of the vehicle and how it was operated (e.g. engine speed, brake application, safety belt usage). To read this data special equipment and access to the vehicle is required. This will take place when the vehicle is serviced in a workshop. Some data is electronically fed into GM global diagnostic systems. The manufacturer will not access information about a crash event or share it with others except

- with the consent of the vehicle owner or, if the vehicle is leased, with the consent of the lessee,
- in response to an official request of police or similar government office,
- as part of the manufacturer's defense in case of legal proceedings,
- as required by law.

In addition, the manufacturer may use the collected or received data

- for the manufacturer's research needs,
- to make it available for research needs where appropriate confidentiality is maintained and need is shown,
- to share summary data which is not tied to a specific vehicle with other organizations for research purposes.

OnStar®

If your vehicle is equipped with an active OnStar® system, that system may also record data in crash or near crash-like situations. The OnStar® Terms and Conditions provides information on data collection and use and is available in the OnStar® glove box kit, at www.onstar.com, or by pressing the **On** button and speaking to an adviser.

Navigation System

If the vehicle has a navigation system, use of the system may result in the storage of destinations, addresses, telephone numbers, and other trip information. Refer to the navigation system operating manual for information on stored data and for deletion instructions.

Radio Frequency Identification (RFID)

RFID technology is used in some vehicles for functions such as tire pressure monitoring and ignition system security, as well as in connection with conveniences such as key fobs for remote door locking/ unlocking and starting, and in-vehicle transmitters for garage door openers. RFID technology in Saab vehicles does not use or record personal information or link with any other Saab system containing personal information.

Radio Frequency Statement

This vehicle has systems that operate on a radio frequency that complies with Part 15 of the Federal Communications Commission (FCC) rules.

Operation is subject to the following two conditions:

1. The device may not cause interference.

2. The device must accept any interference received, including interference that may cause undesired operation of the device.

Changes or modifications to any of these systems by other than an authorized service facility could void authorization to use this equipment.

Index

A

Accessories and Modifications ..	166
Adaptive Forward Lighting (AFL)	125
Adaptive Forward Lighting (AFL) Light	102
Adjustable Air Vents	140
Airbag and Belt Tensioner Light ..	98
Airbag System	46
Air Conditioning Regular Operation	142
Air Intake	141
Air quality sensor.....	133
Antilock Brake System (ABS)	150
Antilock Brake System (ABS) Warning Light	100
Anti-Theft Alarm System	26
Armrest	38, 39
Armrest Storage	80
Automatic Dimming Mirror	29
Automatic Dimming Rearview Mirror	30
Automatic Light Control	125
Automatic Transmission	146

B

Battery	175
Battery Power Protection	132

Battery Voltage and Charging

Messages	112
Boost Gage	94
Brake Assist	152
Brake Fluid	174
Brakes	150, 174
Brake System Warning Light	100
Bulb Replacement	176

C

California Perchlorate Materials Requirements	166
California Proposition 65 Warning	166
Capacities and Specifications ...	231
Cargo Management System	83
Catalytic Converter	146
Center Console Storage	81
Central Locking System	20
Charging System Light	99
Child Restraint Installation Locations	67
Child Restraint Systems	60
Climate Control	15
Clock	91
Compass	91
Control Indicators	96
Control of a Vehicle	143
Convex Mirrors	28
Cross-wheel drive	150

Cruise Control	156
Cruise Control Light	102
Cupholders	79
Curtain Airbag System	56
Customer Assistance Offices	233

D

Danger, Warnings, and Cautions ..	4
Different Size Tires and Wheels ..	206
Doing Your Own Service Work ..	169
Door Ajar Light	103
Driver Information Center (DIC) ..	103
Driving Characteristics and Towing Tips	164

E

Electrical Parking Brake Fault Light	100
Electrical Parking Brake Light ...	100
Electronic Climate Control System	133
Electronic Driving programs	148
Electronic Stability Program	153
Electronic Stability Program (ESP) Light	101
Electronic Stability Program Off Light	101
End-of-Life Vehicle Recovery	167
Engine Compartment Fuse Block	183

Engine Compartment Overview ..	171
Engine Coolant	172
Engine Coolant Temperature Gage	95
Engine Data	228
Engine Exhaust	146
Engine Oil	172
Engine Oil Pressure Light	101
Entry Lighting	131
Event Data Recorders	234
Exit Lighting	131
Exterior Care	220
Exterior Lamp Controls	124
Exterior Lighting	13

F

Fault	149
Filling the Tank	162
Fixed Air Vents	141
Flash-to-Pass	125
Fog Lamp Light	102
Fog Lamps	179
Folding Mirrors	28
Front Airbag System	53
Front Fog Lamps	127
Front Storage	80
Fuel for Petrol Engines	160
Fuel Gauge	94
Full-Size Spare Tire	215
Fuses	182

G

General Information	164
Glove Box	79
Glove Box Cooler	141
Graphic Information Display (GID) and Color Information Display (CID)	105

H

Halogen Headlamps	176
Hand brake.....	151
Hazard Warning Flashers	126
Headlamp High/Low-Beam Changer	125
Headlamps	102
Headlight Aiming	167
Head Restraint Adjustment	9
Head Restraints	33
Head-Up Display (HUD)	107
Heated Front Seats	39
Heated Mirrors	29
Heated Rear Window	32
High-Beam On Light	102
Hood	170
Horn	14, 89

I

Identification Plate	226
Immobilizer	27
Immobilizer Light	102

Information on Loading the Vehicle	86	Mirror Adjustment	10	R	
Instrument Panel Fuse Block	186	Misted Lamp Covers	128	Radio Frequency Identification (RFID)	235
Instrument Panel Illumination	182	N		Radio Frequency Statement	235
Instrument Panel Illumination Control	128	Navigation System	235	Radio Remote Control	18
Instrument Panel Overview	12	New Vehicle Break-In	143	Reading Lamps	130
Interactive Driving System (IDS+)	154	Night panel.....	128	Rear Air Conditioning System ...	138
Interior Care	222	O		Rear Compartment Fuse Block .	187
Interior Lamps	129, 181	Odometer	93	Recommended Fluids and Lubricants	224
Interruption of Power Supply	149	OnStar®	235	Reporting Safety Defects to the United States Government	234
Introduction	3	OnStar® System	119	Reversing Lamps	128
J		Outside temperature	90	Roof Rack	86
Jump Starting	216	P		S	
L		Parking	17, 145	Safety Belt	9
Lane Departure Warning (LDW)	159	Parking Assist	157	Safety Belt Reminders	98
Lane Departure Warning (LDW) Light	100	Parking Brake	151	Safety Belts	40
Lashing Eyes	83	Parking Lamps	128	Safety Locks	24
License Plate Lamp	181	Park Tilt Mirrors	30	Seat Adjustment	9
Load Compartment	24, 82	Passenger Compartment Air Filter	142	Seat Occupancy Recognition	57
Low Fuel Warning Light	102	Power Mirrors	28	Seat Occupancy Recognition Light	99
M		Power Outlets	92	Seat Position	34
Malfunction Indicator Lamp	99	Power Seat Adjustment	35	Selector lever	147
Manual Mode	148	Power Steering Fluid	173	Service	142, 223
		Power Windows	30	Service Display	95
				Service Information	223

Side Airbag System	55	Traction Control System (TCS) ..	153	Wheel Covers	207
Side Turn Signal Lamps	180	Trailer Towing	164	Wheels and Tires	189
Speedometer	93	Transmission	16	Windshield Wiper/Washer	89
Starting Off	16	Transmission display	146	Winter Tires	195
Starting the Engine	144	Tread Depth	203	Wiper Blade Replacement	175
Steering Wheel Adjustment ...	10, 88	Trip Computer	112		
Steering Wheel Controls	88	Turn and Lane-Change Signals	127	X	
Storage.....	79	Turn Signal	98	Xenon Headlamps	179
Sunvisor Lamps	130	Tyre Pressure Monitoring			
Sun Visors	32	System Light	101		
Symbols	4				
T		U			
Tachometer	94	Universal Remote System	120		
Taillamps	179	Unlocking the Vehicle	8		
Theater lighting	132	Using this Manual	3		
Three-Point Safety Belt	43				
Tire Chains	207	V			
Tire Changing	211	Vehicle Dimensions	230		
Tire Designations	196	Vehicle Identification Number			
Tire Pressure	197, 232	(VIN)	226		
Tire Pressure Monitoring		Vehicle Messages	111		
System	199	Vehicle Personalization	114		
Tire Repair Kit	208	Vehicle Storage	166		
Tires	190	Vehicle Weight	229		
Tools	189	Ventilated Front Seats	39		
Towing Another Vehicle	219				
Towing the Vehicle	218	W			
Traction Control System Off		Warning Buzzers	111		
Light	101	Washer and Wiper Systems	14		
		Washer Fluid	174		